



The Future of Russian-US Strategic Arms Reductions: START III and Beyond
 A Meeting Jointly Sponsored by
 The Center for Arms Control, Energy, and Environmental Studies
 The Moscow Institute of Physics and Technology
 and
 The MIT Security Studies Program

The Capabilities of Trident against Russian Silo-Based Missiles: Implications for START III and Beyond

Cambridge, Massachusetts
 February 2 - 6, 1998

George N. Lewis
 Associate Director, Security Studies Program
 Theodore A. Postol
 Professor of Science, Technology, and National Security Policy
 Security Studies Program, Massachusetts Institute of Technology

1

Slide 1

The Implications of Trident for START III and Beyond

Basic Technical Facts

- The currently deployed US Trident II Sea-Launched Ballistic Missile (SLBM) system carries either 500 kt W88 or 100 kt W76 warheads.
- Under standard launch conditions these warheads can be delivered with an accuracy (CEP) of 100 meters.
- By using the GPS satellite system, in combination with the Unistar guidance system, it has been demonstrated that Trident II can repeatedly achieve a 50 meter CEP.
 (see the attached Appendix A at the end of this document for a reprint and references to an article by Admiral G. P. Nanos, Head of the Trident Special Projects Office. The attached article was originally published in the April 1997 edition of *Submarine Review*. The article discusses the accuracy of the Trident II ballistic missile.)
- This briefing shows that if Trident can achieve a 50 meter CEP with the 100 kt W76 warhead, it has a very high capability to destroy Russian silo-based missiles.
- Even with a 100 meter CEP, the Trident W76/Mark 4 has very significant capabilities against Russian silo-based missiles.
- Given the extremely short warning times associated with SLBM attacks, and the technical problems of obtaining adequate and timely attack assessment data, it is possible that Russian silo-based missiles may even now not be capable of Launch Under Attack.
- It is a common security interest of both Russia and the US to correct this situation and create greater stability as we proceed to future arms reductions

2

Slide 2

The Implications of Trident for START III and Beyond

[one can] draw a circle around the ends of a TRIDENT submarine and ... put all the warheads in that circle from 4000 nautical miles away.

Admiral G. P. Nanos, Head, Trident Special Projects Office

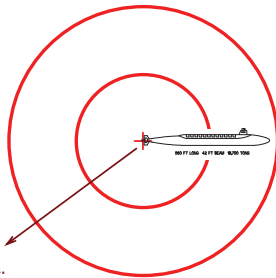

Lowest Accuracy
 Translation of Statement:
 All warheads fall within a
 circle of radius ≈170 meters

3

Slide 3

The Implications of Trident for START III and Beyond

[one can] draw a circle around the ends of a TRIDENT submarine and ... put all the warheads in that circle from 4000 nautical miles away.

Admiral G. P. Nanos, Head, Trident Special Projects Office (see Appendix A at the end of this document for the article)

If the above statement is correct, and one assumes a CEP of roughly 100 meters, then the probability of placing a warhead within a circle of radius 170 meters is equal to:

$$P_{\text{Hit in Circle}} = 1 - 0.5 \left(\frac{R_{\text{Circle}}}{\text{CEP}} \right)^2 = 1 - 0.5 \left(\frac{170}{100} \right)^2 = 1 - 0.13 = 0.87$$

and the probability of placing all 8 warheads from a single Trident II booster into a circle of 170 meters radius is:

$$P_{\text{All 8 Warheads Within Circle}} = P_{\text{Hit in Circle}}^N = 0.87^8 = 0.32$$

It therefore appears that the assumption of a CEP of 100 meters is quite conservative if the claim made in Admiral Nanos' article is true.

We will therefore assume a baseline CEP of 100 meters for our analysis.

4

Slide 4

The Implications of Trident for START III and Beyond

we [have] demonstrated the ability to reduce the [Trident II] ... CEP by half under certain conditions. ... this has not yet been implemented in an operational sense— [but] the capability is there, it is repeatable, and we have verified that.

Admiral G. P. Nanos, Head, Trident Special Projects Office

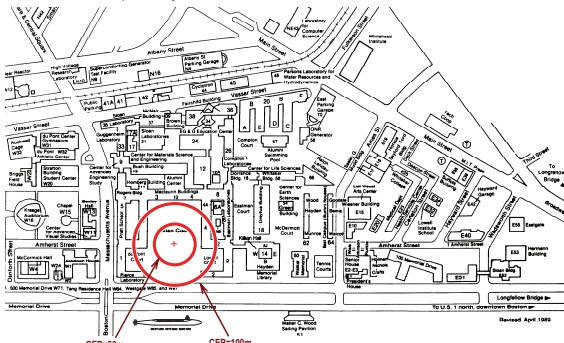

If the above statement is true, it indicates that Trident II CEP is roughly 50 meters. This means a warhead could be delivered within a radius of 50 meters of a target with a probability of 0.5, and to 100 meters of a target with probability 0.94

5

Slide 5

The Implications of Trident for START III and Beyond

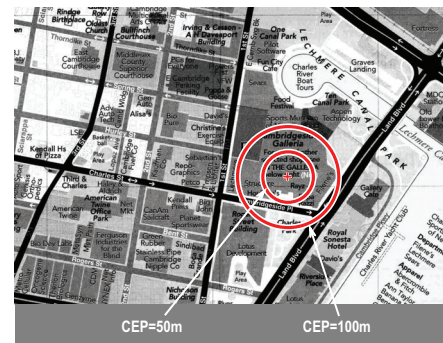

To dramatize the meaning of this accuracy further, we are here in the Sonesta Hotel, and the Galleria shopping mall is only a short walk across the street. If an enhanced accuracy Trident (CEP = 50 meters) were targeted on the center of that building, the trajectories of 90 out of 100 warheads would pass through the platform of the building. At the same time, there would only be one chance in four that one or more of these one hundred warheads would pass through the platform of the Sonesta Hotel.

6

Slide 6

The Implications of Trident for START III and Beyond

[The] capability [of the] Mk 4, however, is not very impressive by today's standards, largely because [it] was never given a fuse that made it capable of placing the burst at the right height to hold other than urban industrial targets at risk.

Admiral G. P. Nanos, Head, Trident Special Projects Office

The Mark 4 warhead is listed as having a yield of 100 kt. The minimum height of burst of the Mark 4 is probably around 560 feet. This guess is likely to be correct for reasons outlined in the slides that follow.

7

Slide 7

The Implications of Trident for START III and Beyond

In the early 1980s, when the Trident Mark 4 first became operational, the Defense Nuclear Agency (DNA) did extensive dust cloud calculations for 100 kt warheads for purposes of fratricide avoidance.

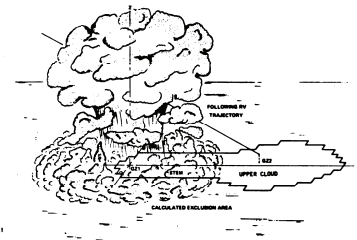
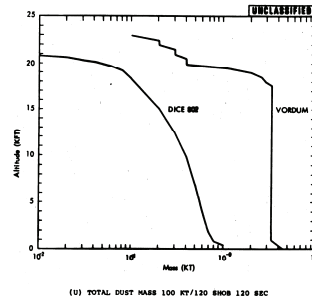

(U) Calculation of Dust Cloud Exclusion Zone

8

Slide 8

The Implications of Trident for START III and Beyond

The calculations were done for 100 kt warheads and burst altitudes of 120 feet Scaled Height of Burst (SHOB). Since the Mark 4 is the only 100kt ballistic warhead in the US arsenal, and it was first deployed at that time, it is likely that these calculations were performed to support the targeting of the Mark 4. Since the SHOB is by definition the height of burst associated with a one-kiloton detonation, the actual burst height for a 100 kt warhead is simply $120 \text{ ft} (100 \text{ kt})^{1/3} \approx 560 \text{ ft}$. Hence, we assume that the minimum height of burst of the Mark 4 referred to by Admiral Nanos is at least as low as 560 feet.

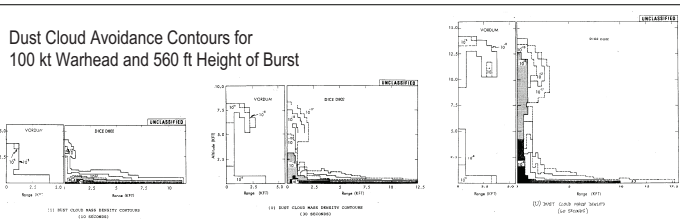

9

Slide 9

The Implications of Trident for START III and Beyond

Our guess that the Mark 4 height of burst is at least as low as 560 feet (120 ft SHOB) is further supported when we examine the peak overpressure versus range for a nuclear detonation at this burst height.

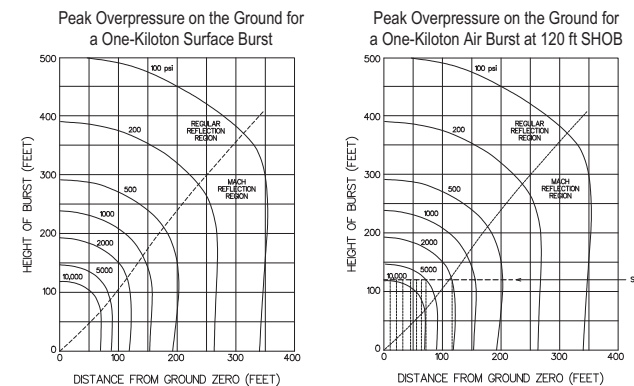

The choice of 560 feet height of burst results in maximum damage ranges for targets that require peak overpressures of between 200 and 2000 psi. Since very high levels of damage are typically sought in nuclear targeting, such high target hardnesses would be common, even expected, in urban environments.

10

Slide 10

The Implications of Trident for START III and Beyond

The peak overpressure versus height of burst curves shown in the previous slide are from page 111 of *The Effects of Nuclear Weapons*, Edited by Samuel Glasstone and Phillip J. Dolan, US Department of Defense and US Department of Energy, 1977.

The peak overpressure versus range for the surface-burst and air-burst conditions shown in the prior slide are plotted below:

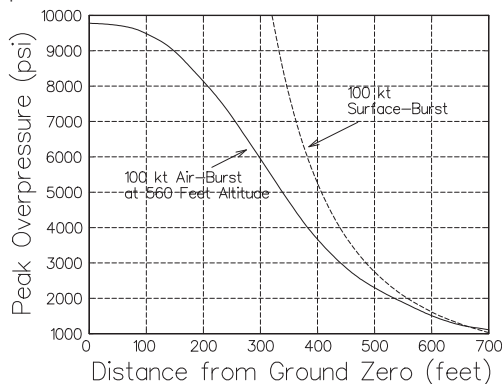

11

Slide 11

The Implications of Trident for START III and Beyond

The different character of the air and surface burst overpressure versus range curves is easily understood by inspection of the two figures below.

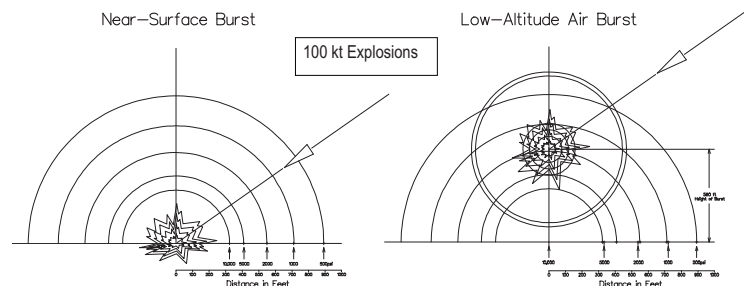

Since the air burst by definition never occurs below 560 feet, the maximum blast overpressure immediately under the detonation is never greater than (but almost equal to) 10,000 psi. In contrast, the maximum overpressure on the ground near the surface burst is much higher, as is the range at which the surface burst creates overpressures of 5,000 to 10,000 psi. Thus, the surface burst is more effective against targets hardened to above 5000 psi, while both the air and surface bursts should have comparable lethal ranges against targets hardened to 2000 psi or less.

12

Slide 12

The Implications of Trident for START III and Beyond

We will show, however, that a W76/Mark 4 air burst delivered with a CEP of 50 meters can achieve the same damage expectancy as a W88/Mark4 surface burst delivered with a CEP of 100 meters against targets up to 6000 psi hard.

Since missile silos are almost certainly no harder than 1500 to 3000 psi, this suggests that the enhanced accuracy W76/Mark4 is adequate for counterforce attacks against the Russian silo-based missile forces.

The calculations presented here also show that the current baseline performance of Trident II, with the W76/Mark 4 air burst delivered with a baseline CEP of 100 meters, even now poses a significant threat to Russian silo-based missile forces.

13

Slide 13

The Implications of Trident for START III and Beyond

Western sources typically state that Russian missile silos are hardened to the nuclear effects of 5000 psi or more, while US missile silos are typically considered hard to about 2000 psi. In reality, it is very likely that both Russian and US silos have roughly the same ability to withstand blast and other effects associated with nuclear detonations. The diagram below makes this point visually for the case of a surface burst.

Dimensions and Peak Overpressures Associated with a 100 kt Near Surface Nuclear Detonation

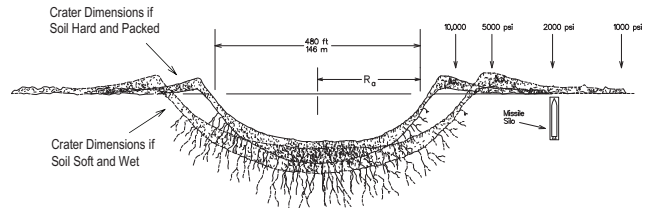

As can be seen by inspection of the crater dimensions, and the overlay of blast overpressure ranges, it is very unlikely that Russian silos could be hard to 5000 psi effects, as even if they could survive the ground shock and air slap they would be buried by debris. It is therefore clear that the hardness numbers typically stated in the West do not reflect the true vulnerability of Russian silos to nuclear burst effects.

14

Slide 14

The Implications of Trident for START III and Beyond

We are now in a position to calculate the probability of silo destruction for CEPs that Trident II can achieve and for a range of structural hardnesses.

The calculation is relatively simple:

We assume that the lethal range for a target of given hardness is equal to the range at which the blast overpressure is equal to the hardness. We use the curves shown earlier for overpressure versus range for the air burst or surface burst, adjusted to a yield of either 100 or 500 kt. We then calculate the probability that the warhead lands a distance equal to or smaller than the "lethal range" R_L for values of the CEP that informs the analysis.

The probability that the warhead lands a distance equal to or smaller than the "lethal range" R_L is given by,

$$P_{\text{Hit Within Lethal Range}} = 1 - 0.5 \left(\frac{R_L}{\text{CEP}} \right)^2$$

The results of these calculations using the blast versus range overpressure curves shown earlier and assuming relevant CEPs are shown in the next slide.

15

Slide 15

The Implications of Trident for START III and Beyond

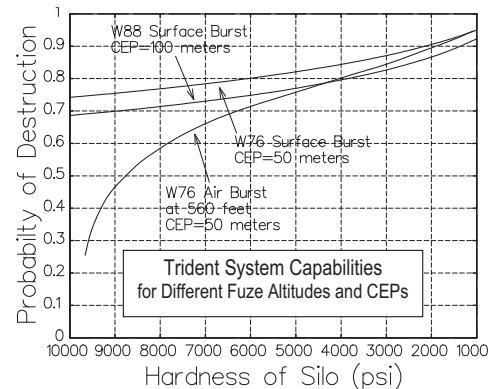

As can be seen by inspection of the resulting graph, the 100 kt Mark 4 warhead with a 50 meter CEP is equally or more capable than the 500 kt Mk 5 warhead with a 100 meter CEP for all targets of 5000 psi or less. Hence, unless Russian silos are significantly harder than 5000 psi, they are vulnerable to destruction by precision Mark 4 air-burst attacks. It is therefore clear that silo-based missiles are, and will be increasingly, vulnerable to sea-based nuclear attack from Trident.

16

Slide 16

The Implications of Trident for START III and Beyond

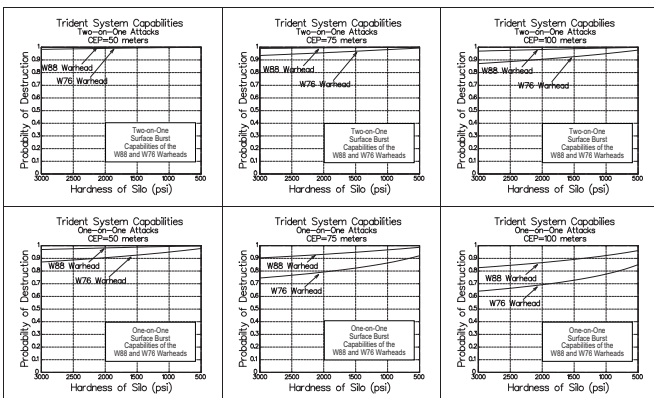

Since at least two warheads would likely be used on each silo-based target, the "two-on-one" probability of destruction is also of interest in this analysis. As can be seen by inspection of the above graphs, the W76/Mark 4 with a surface-burst option and 50 m CEP achieves a two-on-one probability of destruction in excess of .99 for targets harder than 2000 psi. Since our objective is to understand the implications of Trident's accuracy and yield, we do not account for system reliability in our calculations. However, if Trident has a system reliability of .9 or more, the two-on-one destruction probabilities shown in this analysis will diminish by only 1 percent or less.

17

Slide 17

The Implications of Trident for START III and Beyond

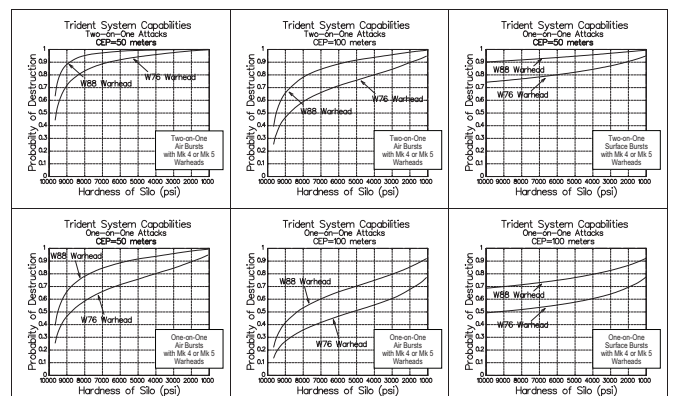

The situation for a Mark 4 air burst delivered with a CEP of 50 meters is essentially the same. The two-on-one probability of the enhanced accuracy W76/Mark 4 with an air burst is also in excess of .99 for target hardnesses of about 2000 psi and below.

18

Slide 18

The Implications of Trident for START III and Beyond

There is an additional very important issue associated with the capabilities of Trident II that have important implications for stability.

The shorter range and flight time of Trident II relative to that of an ICBM like MX poses a major problem for the operation of Russian silo-based missiles.

Measures needed to assure the ability to launch under attack posed by this short timeline could greatly increase the possibility of a massive accidental launch of silo-based missiles.

Correcting this situation in a mutually equitable way is clearly in the common interest of both Russia and the US.

In the slides to follow, we show how the shorter range of Trident II results in diminished warning time for Russian leadership to take actions to launch silo-based missiles in response to a US Trident attack. This situation is exacerbated by Russia's relatively limited infrared early warning satellite system, which does not appear to have substantial wide-area "look-down" coverage of ocean areas where Tridents could be launched. We show that the warning times against a Trident II attack, based on radar detection and tracking, are very short. Under plausible conditions, the time for Russian political leadership to decide to launch under attack could be as short as four to five minutes – or less. Russia reportedly has a "dead-hand" system that would automatically allow lower level command echelons to launch forces once a nuclear detonation occurred on Russian soil. We show that even with the use of a "dead hand" system, it is possible that even the dead-hand could have only two to four minutes or less to successfully launch Russian silo-based forces against a coordinated Trident attack. This very short timeline for even the dead hand system to act is highly problematic, and is a potentially very serious danger to both Russia and the US.

19

Slide 19

The Implications of Trident for START III and Beyond

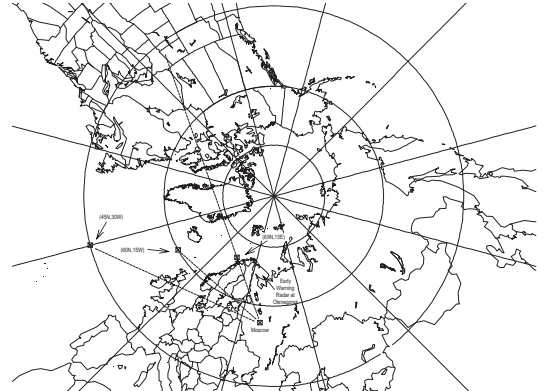

The above map is a Gnomonic projection of the north polar region. On this projection all straight lines are great circle routes. Hence straight lines show the ground-trace and true direction of ballistic missile trajectories. We show three plausible launch locations for a Trident attack on Russia. The location at 69N, 15E is near Andoya Island, Norway, where a rocket launched in 1995 caused a nuclear attack warning alert in Russia. Analysis suggests that the powered flight characteristics and staging of the rocket made it appear somewhat like a Trident. Almost certainly it was first detected and tracked by the Russian early warning radar at Olenegorsk (68N, 33E). The rocket was also in the middle of the great circle path between Grand Forks, North Dakota, and Moscow when it rose over the radar horizon. This location would have put it in the middle of the ICBM attack corridor from Grand Forks to European Russia. It was on a near-vertical trajectory, which could have appeared like a Trident on a mission to blind early warning radars with high altitude nuclear explosions so the radars could then not observe attacking ICBM warheads following from Grand Forks.

20

Slide 20

The Implications of Trident for START III and Beyond



The launch locations shown on the previous Gnomonic projection are shown here on a three dimensional projection of the earth centered at Moscow. This plot is useful because a three dimensional perspective makes it easier to judge distance relative to that on the Gnomonic projection. Since Moscow is chosen at the center of the projection, the great circle traces to launch points are essentially straight lines. Also shown on the figure is the 3500km and 5400km range contours from Moscow. The ABM Treaty demarcation agreement permits testing against "theater" missile targets with speeds of up to 6km/sec. The 6km/sec contour, which results in only a 10 to 15 percent higher interceptor-target closing speed is essentially equal to the speed of arrival of many US and Russian ICBMs. Hence, a US or Russian Theater Missile Defense system built under the provisions of the ABM Demarcation Agreement could have essentially the same capability against strategic missiles as it would have against theater missiles.

21

Slide 21

The Implications of Trident for START III and Beyond

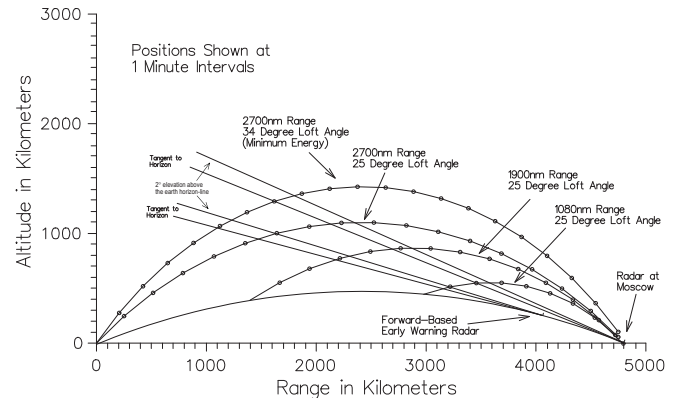

The problems that confront Russian military planners due to the possibility of a short time-line attack using Trident can in part be appreciated by examining the trajectories shown in the above figure. The locations of arriving warheads are shown at one-minute intervals. The line-of-sight of the forward-based early warning radar and the 1080km trajectory closely approximate the observation geometry of the Olenegorsk radar against a Trident launch near Andoya Island. All the trajectories except for one assume launch and reentry angles of 25 degrees, roughly that of a long-range ICBM. The advantage of trajectories with 25 degree loft angles is that the time is reduced between initial detection, when the missiles rise over the horizon, and impact at the target. The problem with such "depressed" trajectories is that the more shallow reentry angle at the target reduces the accuracy, and thereby can reduce the kill probability against hard targets. We will later show that the reduction in kill probability should not be large for this choice of trajectories.

22

Slide 22

The Implications of Trident for START III and Beyond

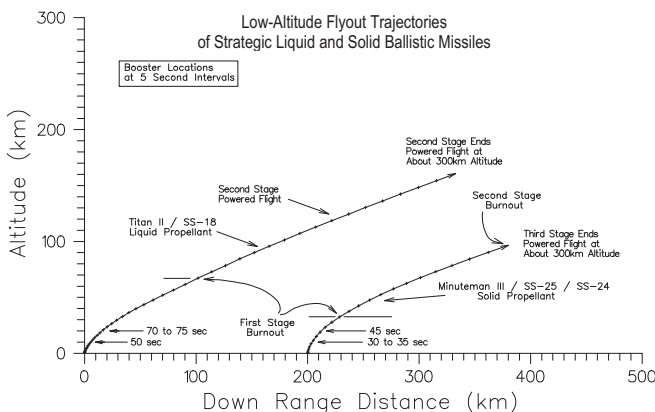

The figure above shows rough time-lines for the powered flight of large liquid and solid propellant ICBMs. The Russian SS-17, SS-18, and SS-19 are all large liquid propellant missiles. As inspection of the figure shows, these missiles require nearly a minute of powered flight-time to achieve a distance of roughly 10 km from their uncovered launch-silo. During this period of flyout, these missiles are extremely vulnerable to the nuclear effects from detonations at ranges of 6 to 10 km. Thus, for a successful launch and flyout, the SS-17, 18s, and 19s would need to be launched roughly one minute prior to the arrival and detonation of warheads that are attacking the silos. This figure and the previous one now allow us to estimate the time that would be available to decision-makers for different relevant attack strategies.

23

Slide 23

The Implications of Trident for START III and Beyond

If a short time-line attack is attempted against Russia, a Russian response aimed at launching silo-based missiles before nuclear weapons detonate on them would require time for several technical operations. Time would also be needed by political leadership to assess the situation and decide whether or not to launch the silo-based missile force. The amount of time available for decision-makers to assess the situation and decide whether or not to launch silo-based nuclear forces is the difference between the time it takes for warheads to arrive at targets and the time needed to carry out operations no matter what response is chosen. An estimate of the time needed to carry out operations no matter what response is chosen is as follows:

Time Needed to Carry Out Basic Nuclear Weapons Launch-Operations

Time for attacking missiles to rise over the horizon into the line-of-sight of early warning radars	1 minute
Time for radars to detect, track, and characterize detected targets, and to estimate the size and direction of motion of targets	1 minute
Time for command and unit elements of silo-based forces to encode, transmit, receive, decode, and authenticate a launch order	1 minute
Time for missile crews to go through full launch procedures	1 to 3 minutes
Time for launched missile to reach a safe distance from its launch-silo	1 minute
Total time consumed in unavoidable and essential operations	5 to 8 minutes

24

Slide 24

The Implications of Trident for START III and Beyond

To get an estimate of the amount of time from launch to impact for different relevant trajectories we assume a Trident launch at 60°N, 0°E, North of the UK. Many other areas of ocean with similarly short ranges to targets are also possible. The ranges and time from launch to impact are as follows:
Assumed Launch Point, 60°N, 0°E.

Range and Time-of-Flight to Targets

Location of Targets	Range (km)	Time for Trajectory (minutes) using a 25 degree Loft Angle
Moscow (55.8°N, 37.6°E)	2237	9.5
SS-18 Field at Kartaly (53.1°N, 60.61°E)	3654	13.6
SS-18 Field at Dombarovsky (50.77°N, 59.5°E)	3752	13.8
SS-18 Field at Aleysk (52.53°N, 82.28°E)	4810	17.0
SS-18 Field at Uzhur (55.32°N, 89.83°E)	4950	17.4

Assumed Launch Point, (58°N, 190°E), Slightly North of the Aleutian Islands.

(Underlies Mishelevka and Pechora radars)

Range and Time-of-Flight to Targets

Location of Targets	Range (km)	Time for Trajectory (minutes) using a 25 degree Loft Angle
SS-18 Field at Aleysk (52.53°N, 82.28°E)	6100	20.8
SS-18 Field at Uzhur (55.32°N, 89.83°E)	5545	19.1

25

Slide 25

The Implications of Trident for START III and Beyond

The above timelines show the following:

If Russian leadership requires that a decision to launch nuclear forces be taken before nuclear weapons detonate on Moscow, leadership would have roughly 1 to 5 minutes to issue a launch order (9 to 10 minutes flight time, 5 to 8 minutes needed to carry out all relevant nuclear operations).

The massive launch of silo-based nuclear forces would have to be authorized with very little detailed information about the nature of the attack. On such a short timeline, only limited information would be available about the size of the attack, and the types and numbers of installations that are targets. Russian decision makers would therefore have to base a decision to launch massively the silo-based missile forces, with all the potential consequences of disaster due to error, with only the most limited information.

Another possibility is that the "dead-hand" system might be used after nuclear detonations begin on Moscow. However, since the flight time to Moscow is roughly 9.5 minutes, and the flight times to European Russian silo fields is about 14 minutes, this would leave only four minutes for actions to launch the forces. Since the issuance of a launch order might take a minute, turn key operations might take one to three minutes, and flyout to safe distance would take another minute, it seems unlikely that anything other than an automated system with pre-delegated launch authority could do the job.

The silo-fields to the east, at Aleysk and Uzhur, would not be hit for 7 to 8 minutes after Moscow, if attacked by Trident from the North Atlantic. This could possibly leave 3 to 5 minutes for a decision to launch. However, if the silos in the east are instead attacked from selected areas of the North Pacific, the Tridents would not be observed by any of Russian early warning radars. This is because the radar search fans from Mishelevka and Pechora are well over a thousand kilometers high at any point where a Trident might cross the search azimuth of the fans. Since the Tridents would be below this altitude at these ranges, they would not be observed by these radars. Thus, if a launch from the Northern Pacific were executed a few minutes prior to the main launch from the Atlantic, Russian leaders would have no radar warning and tracking information indicating that an attack has begun on these sites.

Thus, in theory, it is entirely possible that Russian silo-based forces would not be capable of launch under attack.

26

Slide 26

The Implications of Trident for START III and Beyond

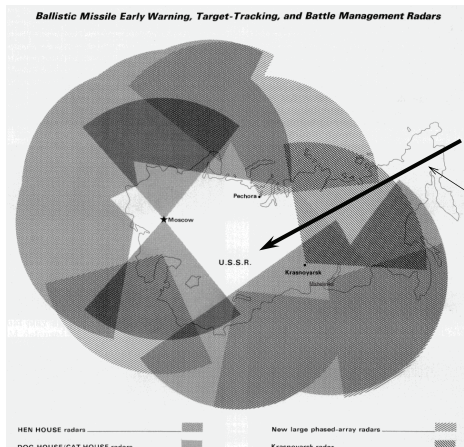

Direction of attack chosen to underlie the radar search fans from Pechora and Mishelevka

By choosing a launch location south or north of the Aleutian Island chain off western Alaska, the Trident missile trajectory would be below the radar horizon for its entire flight period. For example, at the point where the Pechora early warning radar search fan intersects the trajectory shown above, the fan is at an altitude of over 1000 km, well above the altitude of the missile and its warhead.

27

Slide 27

The Implications of Trident for START III and Beyond

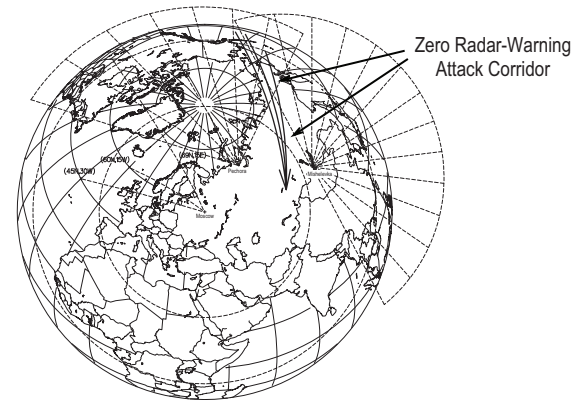

The Zero Radar Warning Attack Corridors are shown above on a three dimensional projection of the earth. Because of the earth's curvature, objects on slightly depressed trajectories (25° loft angles) launched from western areas of the Gulf of Alaska, or slightly north of the Aleutian Islands, could not be observed by the radars at Pechora and Mishelevka. Thus, even if there were high quality space-based infrared warning, there would only be crude information about the direction of the missile trajectories. The lack of confirming detection and tracking data from a radar would also create serious limits on the quality of information needed by leaders to support what would be a momentous decision to launch silo-based missile forces in the central and eastern regions of Russia.

28

Slide 28

The Implications of Trident for START III and Beyond

The situation for Russian leadership would change substantially, although perhaps not adequately, if good space-based infrared warning of such attacks were available. Although the timelines for assessing attacks would still be highly compressed, space-based early warning would greatly enhance the ability of leadership to quickly obtain relevant information for decision making.

Space-based systems can be set up to be essentially independent of and complementary to radar warning systems. Space-based warning also depends on the exploitation of entirely different physical phenomena. As a result, a space-based warning capability provides data that complements observations by radar, and thereby greatly enhances a decision-maker's ability to make judgements about a fast evolving situation. As a result, high quality data from space-based systems could greatly reduce the chances of an accidental or inadvertent launch of forces due to unforeseen failures or malfunctions of the radar warning system.

Russia has for many years had space-based warning system that is deployed in Molnya orbits. This system does not appear to have much ability to detect launches from broad ocean areas, as it is mostly confined to scanning the dark background of space near the earth limb above US ICBM fields. The characteristics of this system suggest that it has little or no ability to observe rocket plumes against the bright background of reflected sunlight from the earth.

Russia appears to be upgrading its space-based early warning system with satellites that appear to have some look down capability into broad ocean areas. The coverage of these new satellites may not provide adequate quality early warning, as it is possible that they have only a limited field of view.

This situation could be greatly improved to the common benefit of both Russia and the US if the US provided Russia with sensing components similar to those used in the US Defense Support Program (DSP) early warning satellite program. The advantage of providing Russia with such components is that Russia could then build its own satellites and operate them with confidence that they are controlled exclusively by Russian authority.

This sensor technology is significantly less advanced than the sensor technologies the US is attempting to exploit for purposes of missile defense. Since the US states that it is willing to engage in cooperative efforts in missile defense, sharing such technology with Russia would constitute a relatively minor transfer of technology.

29

Slide 29

The Implications of Trident for START III and Beyond

The above analysis assumes that Tridents would fly somewhat depressed trajectories at loft angles of 25° in order to compress the time-to-targets.

We now show that using such depressed trajectories would not drastically reduce the accuracy of Trident.

In fact, this analysis indicates that Trident with the W76/Mark 4 100 kiloton warhead using enhanced accuracy techniques would have a very high kill probability against Russian silo-based missiles.

30

Slide 30

The Implications of Trident for START III and Beyond

We start by showing that the "aiming" capability of Trident would not drastically change for shallower loft angles *provided* that the submarine has good initial position data at launch – like that from a GPS update prior to launch. By "aiming," we mean the ability of the guidance system to place the warhead at the proper loft angle and azimuth to bring it to the target.

The other major contribution to target miss is due to dispersion during low-angle atmospheric reentry. We show that dispersion due to the lower reentry angle should not degrade the accuracy of the Mark 4 enough to take away its anti-silo capabilities.

31

Slide 31

The Implications of Trident for START III and Beyond

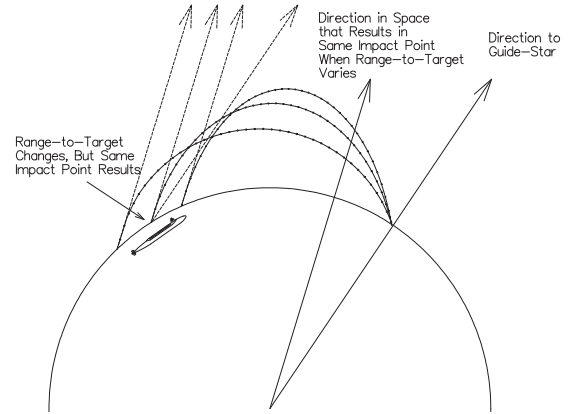

The diagram above shows in concept how the Trident's stellar-inertial guidance system achieves high accuracy. The azimuth to the target is determined by choosing a guide star that is over (or nearly over) a target of interest. The loft angle required to hit the target is also determined from the direction to the star. If the submarine's position is not exactly known, a loft angle can be chosen which causes the warhead to fall the same distance short or long of the target as that associated with the unknown distance error between the submarine and the target. This clever system for correcting for direction and range to a distant target is known as the *Unistar* System. A novel and interesting feature of this system is that it allows, at least in principle, for the submarine to hit targets with higher precision than that of the known location of the submarine.

32

Slide 32

The Implications of Trident for START III and Beyond

The graph to the right demonstrates the reduction in "aiming error" that occurs when a stellar-inertial guidance update is used instead of pure inertial guidance.

The zero-shift loft angle shown in the graph is the shift in loft angle relative to the minimum energy loft angle. For a range of 4000 nmi, like that shown to the right, the loft angle for the minimum energy trajectory is 28.4° (with a 6.7 km/sec velocity), very close to the 25° loft angle assumed in the timeline analysis presented earlier. For the launch conditions shown on the graph, the pure inertial guidance system has a down range impact error of about 770 feet. If a star tracker update is used, and the Trident is flown on a minimum energy trajectory, the down range miss error is reduced to 500 feet.

If a trajectory with a loft angle of 43.4 degrees is instead chosen (with 7 km/sec launch speed and shown in the graph as a 15° shift in the loft angle), the miss error is dramatically reduced to less than 100 feet (less than 30 meters).

This is because when the guidance system adjusts the loft angle by tilting on the star direction it results in changes in the loft angle that cause the warhead to fall the same distance short or long of the target as that associated with the distance-to-target errors.

Note also that when the error in launch location is small, due to, for example, a GPS update before launch, the system errors are reduced and nearly independent of the choice of trajectory. Thus, the aiming error is not strongly affected by the choice of trajectory if the location of the launch point is well known.

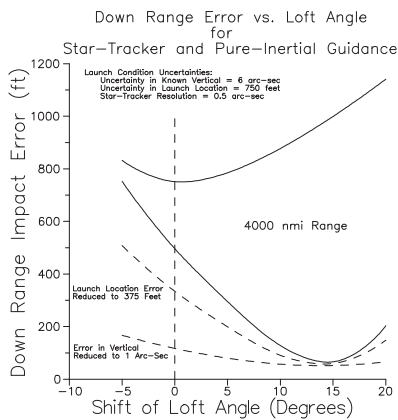

33

Slide 33

The Implications of Trident for START III and Beyond

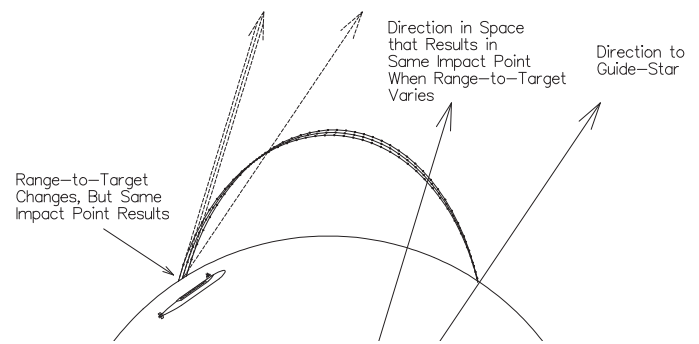

The flight paths shown above are actual calculated Keplerian trajectories for a 43.4° loft angle and 7 km/sec. These trajectories are close to the enhanced accuracy trajectory conditions discussed in the previous slide. As can be seen from the diagram, if the submarine is too far from the target, the star-siting will result in a slightly smaller loft angle and result in a greater (and compensating) flight distance to the target. If the submarine is instead too close, the loft angle will be larger, resulting in a shorter flight distance to the target. Thus, by siting on a single star it is possible to hit the target with greater precision than the known launch location.

34

Slide 34

The Implications of Trident for START III and Beyond

The figure at the right shows how the Trident system effectuates a stellar-update.

After launch, the missile undergoes powered flight using three propulsion stages. At the end of powered flight, the "equipment section" is placed on a ballistic trajectory towards a set of targets.

The equipment section of the Trident I can carry 8 100 kt Mark 4 warheads. The Trident II equipment section can carry either 12 100 kt Mark 4s or 8 500 kt Mark 5s.

The equipment section, often called the "BUS," has its own guidance and propulsion system. The BUS orients itself so that the inertial guidance system can site on a guide-star. The expected position of the guide-star in the field of view of the guidance system's sighting device is compared to the observed position. This information is then used to correct the guidance system errors at this point in the missile's flight trajectory.

Once the updated navigation constants are determined, the BUS begins the process of deploying each warhead on trajectories towards targets.

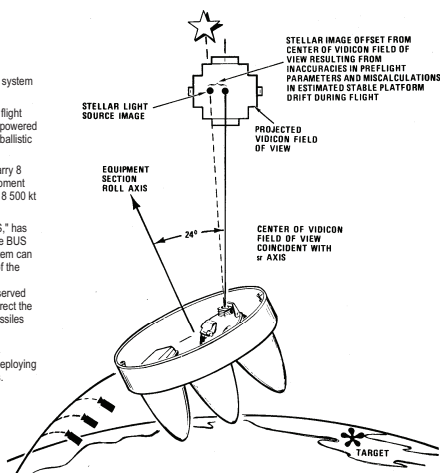

35

Slide 35

The Implications of Trident for START III and Beyond

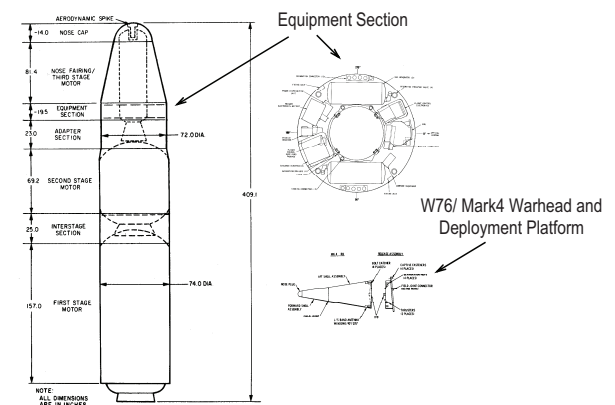

The three figures above show the overall configuration of the Trident I, which is similar to that of the Trident II as well. The long and narrow third stage rocket motor passes through the center of the equipment section. In the case of Trident I, 8 Mark 4 warheads can be mounted on the "doughnut" like equipment section. Details of the equipment section and warhead assembly are broken out for inspection in the diagram above.

36

Slide 36

The Implications of Trident for START III and Beyond

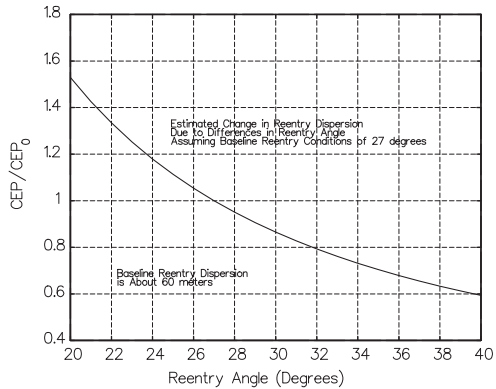

The MX is supposed to have an overall CEP of 100 meters, and it reenters at an angle of 25 to 27 degrees. This means that if the aiming and velocity errors are approximately equal to the reentry error, then the reentry error must be roughly 60 to 70 meters. The above graph shows the ratio of the reentry error at different loft angles to the reentry error at 27 degrees.

43

Slide 43

The Implications of Trident for START III and Beyond

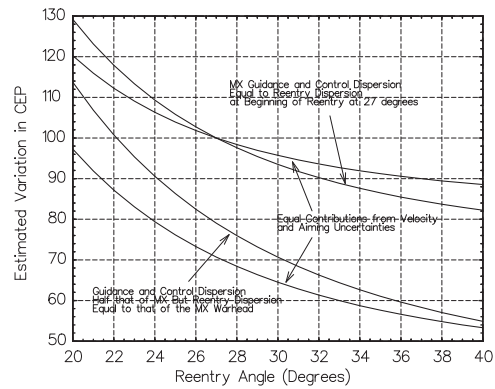

The above graph shows the approximate CEP of the Trident as a function of reentry angle assuming that the combined aiming and velocity errors are roughly equal to the reentry error, or the aiming and velocity errors are each roughly equal to the reentry error. It is clear that if the MX can achieve a 100 meter CEP, then Trident could well achieve the reported 50 meter CEP for reentry angles of 35 to 40 degrees. It also appears that it should be able to achieve an accuracy of 70 to 80 meters at the lower reentry angle of 25 degrees.

44

Slide 44

The Implications of Trident for START III and Beyond

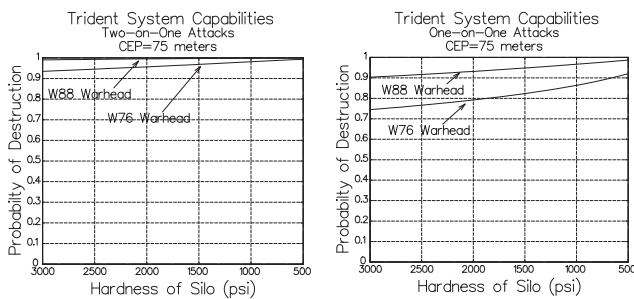

The implications of Trident's potential accuracy for the survival of silo-based missiles are shown above for 100 and 500 kt warheads that are detonated at the earth surface. When the real-world uncertainties in the true target hardness of silos and the details of weapons delivery are considered, there appears to be little or no difference in the silo-killing power of either the Mark 4 or Mark 5 warhead.

45

Slide 45

The Implications of Trident for START III and Beyond

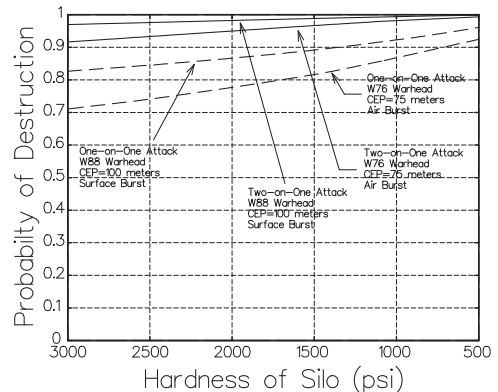

The above graph also shows that the enhanced accuracy Mark 4 warhead is also capable of destroying, with very high probabilities, Russian silo-based missiles using slightly depressed short-warning time trajectories with reentry angles of 25 degrees.

46

Slide 46

The Implications of Trident for START III and Beyond

It is therefore clear that the current Trident II force, armed only with 100 kt Mark 4 warheads, poses a very serious and credible threat to Russian silo-based missile forces.

It is in the common security interest of both Russia and the US to address this serious problem in the arms control measures to be adopted in START III and beyond.

47

Slide 47

The Implications of Trident for START III and Beyond

An Objective for START III and Beyond

48

Slide 48

The Implications of Trident for START III and Beyond

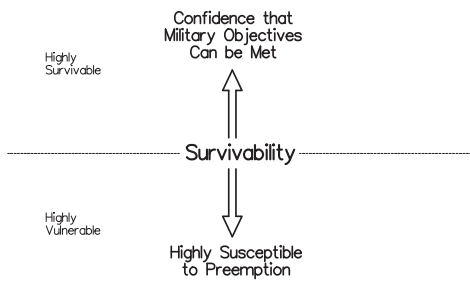

The figure above conceptually illustrates the fundamental underlying issue discussed in the earlier sections of this briefing. Since silo-based missile systems are vulnerable to nuclear attack with modern nuclear-armed ballistic missiles, they are susceptible to preemptive attack.

49

Slide 49

The Implications of Trident for START III and Beyond

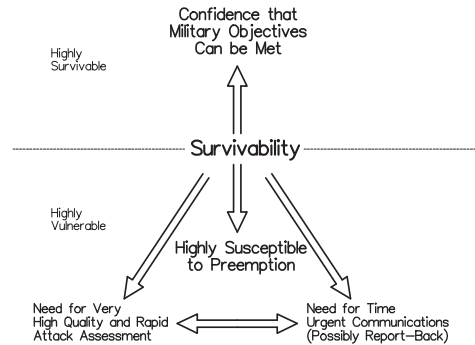

Because of this vulnerability to preemptive attack, it is absolutely necessary that they be supported by high quality, rapid, and non-disruptible early warning and communications systems. The successful functioning of the early warning, communications, and launch operations are tightly dependent on each other. If early warning fails to alert the system quickly enough, there will be no time to communicate launch orders and to launch the forces. If early warning works, but communications is disrupted for only a short time, launch of the force will also fail. Beliefs that it might be possible to stop a retaliation by simply disrupting, without necessarily destroying, either early warning or communications could lead to an increased risk of a massive accidental launch of forces or even encourage an enemy attack during a crisis. The tight interdependence of all systems on each other and the high performance demands on each subsystem are entirely a result of the technical requirements created by the vulnerability of the nuclear retaliatory system that is to be supported.

50

Slide 50

The Implications of Trident for START III and Beyond

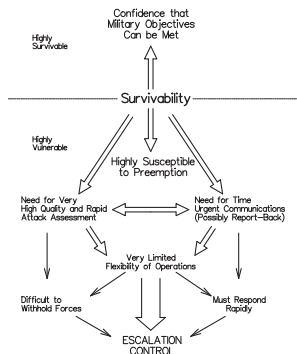

The problems created by a vulnerable nuclear retaliatory system go much deeper than simply being susceptible to preemption. Because the system is vulnerable, there is very little flexibility of operations. All operations must be done as quickly as possible, leaving no opportunity to withhold forces, or to gradually respond to an enemy action. The result is a force that is only likely to work if it is very rapidly and massively launched. This means that political decision-makers would be faced with a most momentous decision to be taken in minutes, or perhaps even in a shorter time interval. Escalation control, of any kind, would be fundamentally impossible under any and all conditions.

51

Slide 51

The Implications of Trident for START III and Beyond

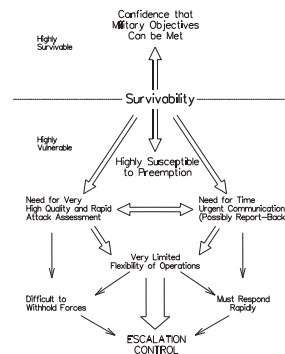

Vulnerability Creates Need to Respond Rapidly.

1. In Crisis, Creates Great Pressure on Political and Military Decision-makers.
2. Time-Pressure Greatly Limits Military Options. Plans Must Be Rigid. Coordinating Retaliation with Remaining Forces Would Be Difficult.
3. Other Considerations. Size of Forces Susceptible to the Quality and Quantity of Enemy's Forces.
4. Arms Reductions Complicated. Reductions Filled With Difficult and Ambiguous Choices Due to Vulnerabilities That Must Be Considered.

The policy problems of vulnerable nuclear weapons systems are quite serious in terms of both the long and short-term pressures they create on political leaders. Vulnerable systems require that political leaders make a major effort to be involved in details of military operations, making it much more difficult for leaders to focus on dealing with the political issues that may have caused a crisis. Also of concern is that engaging in arms reductions with forces that have significant vulnerabilities requires careful and detailed analysis of inevitable security cost and benefit tradeoffs – driven by the vulnerabilities of the systems. For example, reducing the number of Russian and US nuclear weapons could have valuable security benefits for both countries. However, a small Russian silo-based force would be more vulnerable to a preemptive attack than a large one. In contrast, a small Russian nuclear force that is not subject to preemptive attack could be effectively bartered for a small US force, thereby reducing the physical dangers and economic costs to both countries.

52

Slide 52

The Implications of Trident for START III and Beyond

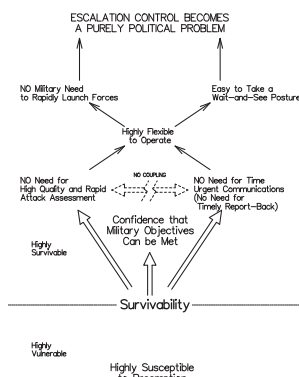

- NO Need to Respond Rapidly
5. In Crisis, Political Decision-maker Does Not Need to Closely Manage Military Forces.
 6. As a Result, the Decision-Maker Always Has the Option to Take a Wait-and-See Posture
 7. Great Flexibility in Choosing Military Options. Plans can be Flexible, or Even Ad Hoc. Coordinating a Retaliatory Attack is NOT Difficult
 8. Other Considerations: Size and Ultimate Capability of Own Forces Unaffected by the Quality and Quantity of Enemy Forces.
 9. Arms Reductions Technically Uncomplicated. Few or No Difficult Technical-Military Choices. Leaders Can Totally Concentrate on the Political Issues Associated with Force Reductions

Thus, if future nuclear forces can be based in ways that are survivable, this would result in enormous common security benefits to both Russia and the US. Both countries could greatly reduce the dangers and costs of maintaining nuclear forces, while at the same time having a robust and effective deterrent against any adversary, no matter how capable an adversary's nuclear forces might appear. It is therefore an appropriate objective for START III and beyond, that both Russia and the US cooperatively seek to find ways to greatly reduce and reconfigure their nuclear forces so as to make them highly survivable. We suggest some steps towards this goal in our conclusions and recommendations section.

53

Slide 53

The Implications of Trident for START III and Beyond

Conclusions and Recommendations

54

Slide 54

The Implications of Trident for START III and Beyond (1 of 4)

- Cooperatively improving both the capabilities of warning and attack assessment systems, and the survivability of strategic nuclear forces, will make it possible for political leaders to always take a wait-and-see posture in a nuclear crisis situation.
- Russia and the US should therefore consider an explicit arms reduction strategy that strives to reduce the dangers of accidental or inadvertent use of nuclear weapons due to time-pressures that could lead to unintended interactions between their forces.
- This strategy should include efforts to improve early warning systems and increase the survivability of both countries' nuclear forces.

In particular:

- Both sides should aim to have high quality space-based infrared early warning systems that can observe the launch of ballistic missiles worldwide.
- One way to help implement this goal, would be for the US to share with Russia infrared optical sensing and signal data processing technology of the kind that has been used in the US Defense Support Program Satellites.
- Russia should consider building its own infrared early warning satellites using this technology. These satellites should be completely under Russian control.

55

Slide 55

The Implications of Trident for START III and Beyond (2 of 4)

- To increase the reliability of these systems, as well as their utility, Russia and the US should engage in a regular exchange of infrared early warning and phenomenological data relevant to the operation of their respective infrared early warning systems.

This kind of cooperation appears quite consistent with the texts of agreements reached by Presidents Yeltsin and Clinton in both the March 1997 and May 1995 summits.

It is also consistent with the objective of improving stability through deep reductions and reconfiguration and operation of nuclear forces to enhance survivability.

56

Slide 56

The Implications of Trident for START III and Beyond (3 of 4)

- Both Russia and the US should consider explicitly adopting a policy of very rapid and deep reductions in forces aimed at increasing the stability of nuclear forces and thereby reducing the danger of inadvertent interactions between Russian and US forces.

The practical reasons for an explicit rapid deep reduction policy are as follows:

- The economic costs of operating and modernizing small nuclear forces would be greatly reduced, freeing resources to emphasize survivable basing modes and operations.
- An explicit agreed on policy of emphasizing small survivable nuclear forces would allow both Russia and the US to concentrate limited resources on maximizing stability, and thereby reduce the danger these forces pose to both countries.

57

Slide 57

The Implications of Trident for START III and Beyond (4 of 4)

- The problem of nuclear-armed cruise missiles needs to be addressed specifically in terms of the danger they pose for zero warning attacks. If central strategic forces are configured and operated so they are highly survivable, the disarming consequences of such an attack would be greatly reduced, but the possibility of zero-warning nuclear attack is still a very serious problem.
- Nuclear-armed cruise missiles create the danger of zero-warning nuclear attack because they are very hard to detect, and can readily be routed around national early warning systems. Building warning systems capable of denying both Russia and the US the ability to attempt a zero-warning nuclear cruise missile attack against the other could readily cost each country several tens of billions of dollars.
- There are no nuclear missions that Russia or the US could not accomplish against a third party that requires nuclear-armed cruise missiles.
- From the perspective of stability, at least, it therefore appears to be in the interest of both countries to forego nuclear-armed cruise missiles and to adopt verification measures with regard to these systems.

58

Slide 58

The Implications of Trident for START III and Beyond

Appendix A

Article about the Accuracy of the Trident II System by Rear Admiral G. P. Nanos, Director of the Trident Strategic Systems Program

59

Slide 59

STRATEGIC SYSTEMS UPDATE

By Rear Admiral G.P. Nanos, USN
Director, Strategic Systems Programs

It is my pleasure as the Aerospace Arm of the submarine community to provide an update on our thinking and our progress.

Usually, our deployed forces are the last part of a strategic systems presentation, but they are not the end of the story, they are the beginning and I just want to remind you of what we have deployed today. I am then going to spin off of that and tell you what we can do in the future and how we are going to get there.

Of course, the mainstay of our deployed force has been TRIDENT I C4 which has the Mk 4 warhead and the W76 reentry body. With over 700 patrols, over 170 flight tests and over 17 years of operation, this system has exceeded all our expectations for range and for reliability and in the case of accuracy we have exceeded requirements by almost a factor of two. By every measure this is an exceptional system and meets all requirements, but it is aging. Although we intend to keep C4 in service longer than we have any other fleet ballistic missile and have learned a great deal from it, we are in the last decade of its life.

Our more modern Trident II D5, with not only the Mk4, but the new Mk5 warhead, is designed to have higher accuracy, higher yield, and be able to penetrate during extreme weather. We have commissioned the ninth D5 submarine in the Atlantic, the tenth is in the water and with the eighth on patrol, the major portion of our submarine based deterrent will from now on be Trident II.

Let's talk about D5 performance. My predecessor twice removed, Admiral Ken Malley, used to say you could draw a circle around the ends of a TRIDENT submarine and could put all the warheads in that circle from 4000 nautical miles away. That sets a reasonable, unclassified scale for the performance of the D5 system. We are up to 91 patrols, 58 flight tests, and 6 plus years of operation. Now, we can describe to you about where we are going to go with this system, starting with the systems role in the strategic deterrent force. For example, we ran a test in one DASO where we demonstrated the ability to reduce the system CEP by half under certain conditions.

A comment was made and a question posed several years ago by General Lee Butler about what could be done with a single

missile. He postulated that if the National Command Authority ever elects to use strategic missiles, they may elect to do it on a one missile basis. So, we looked at something we called Super-groom. We asked the question: "If you really wanted to optimize an engagement what could you do?" It turns out if you groom a missile, freshly calibrate the guidance system, come to periscope depth, take GPS data to fill a Kalman filter with which to correct the ship's inertial navigation system, then immediately return to depth and launch it at a time such that the guide star for the stellar-aided inertial guidance system is exactly in the right place relative to the target, you can, in for certain scenarios, halve the CEP of a current TRIDENT missile. Although this has not yet been implemented in an operational sense—there's a lot of work that needs to be done in terms of doctrine and procedures—that capability is there, it is repeatable, and we have verified that.

Accuracy is really the coin of the realm in strategic deterrence in all forms, both conventional and nuclear, for the future. Let me expand on that a little bit.

We can chart the capability of our weapon system against targets and see what accuracy has done for us. The demonstrated capability of the D5 is excellent. Our capability for Mk 4, however, is not very impressive by today's standards, largely because the Mk 4 was never given a fuse that made it capable of placing the burst at the right height to hold other than urban industrial targets at risk. With the accuracy of D5 and Mk 4, just by changing the fuse in the Mk 4 reentry body, you get a significant improvement. The Mk 4, with a modified fuse and Trident II accuracy, can meet the original D5 hard target requirement. Why is this important? Because in the START II regime, of course, the ICBM hard target killers are going out of the inventory and that cuts back our ability to hold hard targets at risk. The Air Force has some plans for how to upgrade their ICBM force to restore that capability. We can do that with the Mk 4 reentry body for 10 cents on the dollar in terms of investment because of the accuracy of our system, and we have made this option available to the strategic CINC.

The D5 production schedule is an important issue for us because it equates to a large amount of submarine force dollars. There are two important aspects of the program that relate to this cost. Number one, the level of production for D5 missiles is low. It turns out that we have gone from the rate of six a month

12

13

60

Slide 60

The Implications of Trident for START III and Beyond

production down to one a month production with only a 25 to 30 percent increase in unit cost. I think this is a real tribute to your strategic industrial base, because by doing that, they have opened up the dollars in the top line for other submarine programs. I feel really good about the contributions of Lockheed-Martin and others in terms of realizing this level of control. I think that a decrease factor of six with only a 25 to 30 percent increase in unit cost is extraordinary and probably without precedent. Another key cost factor is that the reliability of the D5 weapon system has allowed the missile inventory number to be kept very low. I fly two less D5 missiles a year than I do for C4 based solely on the reliability of the D5 system; this equates to over 50 million in savings a year. The capability of the D5 system is hitting us in the pocketbook in a very beneficial way.

The schedule for the D5 conversion of our TRIDENT I submarines is in place. Of course as we enter into force with TRIDENT II, there is a question mark about what we do with the last four Trident I submarines: the ones not scheduled for backfit. Everything is being driven by the START treaty entry into force in terms of our plans. That is what will drive the elimination of the four non-D5 converted TRIDENTS, or conversion of those to other uses.

There is a continuing need in the Navy for covert special operations capability, for mine warfare capability and also the need to introduce more survivable vertical strike modules capable of handling Tomahawk and tactical ballistic missiles. We have worked very closely with N87 and NAVSEA to come up with affordable options for doing this, using converted Trident I submarines. You can have a broad range of options, anywhere from 125 to almost 200 strike missiles, combine that with special operations capability and even support all three missions in the same submarine. This is an extremely capable platform and we have worked very hard to come up with solid affordable options to allow us to extend its life.

We can also put some conventional warfare bite into this submarine and into the 688 with the vertical launch tubes. We have adopted a partnership role with the Army and have signed up to work with them very closely in a broad number of areas associated with missile technology. The Army tactical missile people are extremely competent, steadfast and good partners with extensive experience in tactical missiles. We bring to the game

underwater-launch strategic missiles and perhaps, most important from the Army standpoint, expertise in hypersonic vehicles that can be used to deliver lethal force, particularly hard target penetrators on the battlefield. The Army, aside from a broad range of capability in tactical missile systems, also has extensive capability in the area of brilliant anti-tank munitions, multi-sensor terminal guidance and sensor fuzed weapons. We have been doing a lot of work with the Army and I'm going to update you on that. First of all, we did actually price a program to put ATACMS in a 688 submarine. We are continuing to work that hard, with particular emphasis on cost. We have also signed up, with our Army partners, to pursue the JROC approved mission need statement for hard and deeply buried targets. This program has gone to Milestone 0 and the Army is working with us to provide both sea-based and land-based weapons that can work with that. Perhaps the most important thing that has happened year is that we have an approved, OSD funded technical demonstration where we and the Army will demonstrate capability against hardened counter proliferation targets and weapons of mass destruction. As part of that activity we will fly a hard target penetrator in a Mk 4 reentry body from an ATACMS missile in 1999.

For submarine launched ATACMS, there is no magic involved. It involves taking existing operational systems and putting them together. Clearly, the trick is to make that missile fit the Tomahawk launch tube and to do that you have to make it a little bit longer and redesign the fins so that they will tuck in tighter.

It turns out that the former Loral, now Lockheed Martin Vought, is going to invest their own funds to reduce development risk further.

As an example, a casting was required to extend the missile so that the fins can fold into a smaller diameter. Again, this was done by Loral on their IR&D funding and they are going to build this up into a mockup of a submarine launched ATACMS missile.

In addition, we have an actual prototype of a casting of a submarine launched ATACMS fin which will go into that mockup missile that they're putting together. My only commitment on the government side is to say if they build it I will wheel it into the Pentagon and around the E-ring one time to show everybody the commitment of industry to this program and the Submarine Force.

One other piece that has to be done is a new cable tunnel to

allow the missile to fit into the launch tube. This also represents a significant commitment on the part of the Army. This is a type of modification to the missile which will not affect the Army's employment of the missile and the Army is willing to incorporate the change into all versions of the ATACMS missile, even their own. If we do the development for SLACMS, they are willing to introduce modifications like this into their production missile to make it more affordable for us to get online with their production. So the Army is also playing very strongly and very supportive of our use of their missile.

The counter proliferation demonstration that I spoke about earlier will involve firing an ATACMS missile from the only launcher we have available, the M270, against a cut and cover bunker of the type used to house counter-proliferation targets. The missile will incorporate a Navy Mk 4 reentry body modified to carry a conventional earth penetrator and a control system, into a target out at White Sands Missile Range. After the tests prove the capability, a residual capability consisting of one Army artillery platoon equipped with penetrators will be available. There is no reason that the residual capability couldn't be a 688 submarine, but unfortunately we have to get the missile adapted to the submarine in order to make that happen. Once we become ATACMS capable, this capability will be available for us.

It turns out that in some areas this type of weapon plays very heavily. There was a joint multi-warfare analysis game run in the MRC-West scenario. It showed that although we turned back the tide, we did it at great cost, because there are a lot of the North Korean targets that we need to suppress that were just unattainable with our current order of battle.

The original game showed that against Seoul, for example, the North almost took Seoul and attained 90 percent of their objectives before they were turned back. By being able to take out the strategic artillery, the Nuclear Biological and Chemical capabilities, the C4I with the ATACMS penetrator the attack was turned back very quickly. They never attained more than 25 percent of their goals and it took eleven days out of that particular campaign. Overall in the MRC, it took eight days out of the campaign. In this game, the weapon was deployed from submarines, surface ships and from Army units in country.

Is it always going to be this good? Well, it's like automobile gas mileage; it depends on how you drive the car or in this case

what scenario you are in. If you have hard targets that are a key to battlefield success and you can patrol along the coast to get within range and wait covertly, the submarine ATACMS combination plays very, very heavily. It really makes a dramatic impact on this particular MRC. This is the most impact, I understand, that they ever had from the introduction of a single weapon into a war game like this in terms of its effect on the outcome.

In going after hard targets, we have discussed how we are going to fly a new warhead on ATACMS. That has been funded. Although we are building it for ATACMS, it is built in a Mk4 reentry body and we can use a version of it on a strategic missile to address conventional targets at long range. This would allow a penetrator to be deployed out to four to six thousand nautical miles, delivered accurately, and be able to be gotten on target in the first hour of a conflict. In fact just a tungsten plug in a reentry body at fall reentry velocity will do a great deal of ground shocking and cratering.

The Army likes our approach. We are working closely with them. It's a good effort. I think we have a lot of promise in both the long and the short range missile. Of course the strategic CINC has to agree to use of his strategic assets for conventional use. This is because, under the START treaty he is going to give up a weapon in the STOP for each conventional weapon deployed.

In summary our main line programs are doing extremely well. Performance is in good shape. The team of the Type Commanders and the Fleet are working hard to keep the strategic force deployed and capable.

The existing off-the-shelf technology that's available to us today means that we can really extend the capability of these systems both in the strategic venue, as I mentioned with what a simple fuzing change will do for the Mk 4 reentry body, and also by expanding the role of submarines and submarine-launched missiles to other critical mission areas and conventional deterrence. I think there's a great future for ballistic missiles, aerospace and the Submarine Force together.

Submarine Review
April 1997, pp. 12-17