

# Ending enchantment: LANL's plans for plutonium pit production and weapons expansion

Greg Mello, Los Alamos Study Group, 23 Aug 2019

"I am become death, destroyer of worlds."

*Bagavat Gita*, [recalled](#) by Robert Oppenheimer at the Trinity Test, July 16, 1945

"Thus it is that those to whom destiny lends might, perish for having relied too much upon it....Only he who knows the empire of might and knows how not to respect it is capable of love and justice."

Simone Weil, "The Iliad, Poem of Might"

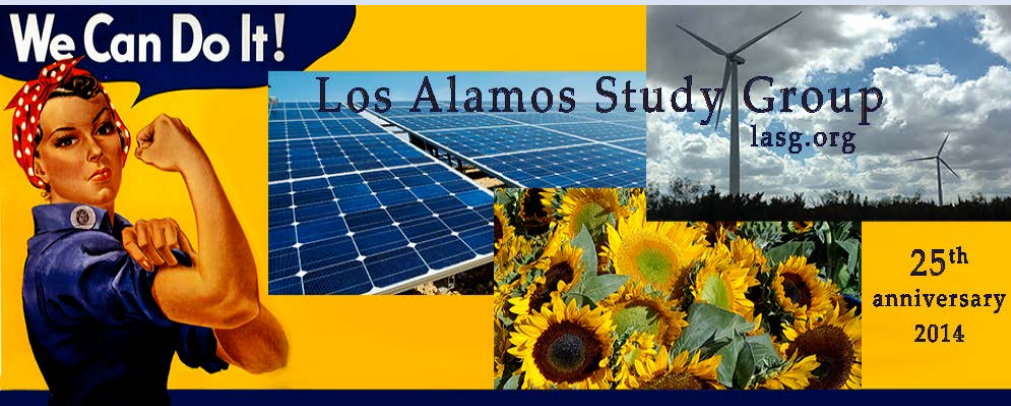

To subscribe to the Study Group's main listserve send a blank email to [lasg-subscribe@lists.riseup.net](mailto:lasg-subscribe@lists.riseup.net)



Los Alamos Study Group  
2901 Summit Place NE  
Albuquerque, NM 87106  
[www.lasg.org](http://www.lasg.org), 505-265-1200

[Write](#) if you would like to be part of our activist network. We have retired our Facebook page. Twitter: [@TrishABQ](https://twitter.com/TrishABQ); Blog: [Remember Your Humanity](#)

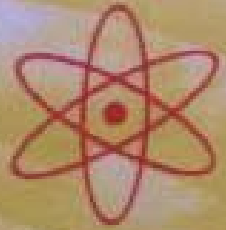

**Welcome to New Mexico**

**America's Nuclear Weapons Colony**

[www.lasg.org](http://www.lasg.org)



# MEXICO

[www.lasg.org](http://www.lasg.org)

- ✓ #1 in nuclear weapons
- ✓ #1 in poverty

**COINCIDENCE?**

# Stockpile Stewardship: How do we sustain the nuclear deterrent



501835  
B61 12  
SERIAL 020970

B612  
US Air Force  
Strategic Bomb

B617  
US Air Force  
Strategic Bomb

## New Mexico's largest public infrastructure investments

In relation to LANL capital projects (LCPs) planned, FY2020 – FY2030 (\$13 billion)

(Costs are best available; dates mostly at completion)

Project	Year	Cost Then (\$M)	Cost in 2019 (\$M)	Percent LCPs
Elephant Butte Dam, NM	1916	5.2	262	2%
(Golden Gate Bridge, CA	1937	35	1,003	8%)
San Juan Chama Diversion	1964	>35	>321	>2%
Cochiti Dam, NM	1975	94.4	406	3%
LANL TA-55 PF-4	1978	75	251	2%
I-40 + I-25 + I-10 highways, NM (treated here as one project)	1956-1995	~7.4 M/mile, 2006 dollars	Ballpark 9,207	71%
Big I Interchange, Albuquerque	2001	290	455	4%
San Juan Chama drinking water project, Albuquerque	2008	280	334	3%
Railrunner Heavy Rail Extension to Santa Fe (incl. track lease)	2008	~400	~477	4%
LANL DARHT (very approximate)	~2008	~ 400	~477	~4%
SNL MESA Complex	2008	516.5	616	5%

# 12,094 People: Our strengths are the diversity and quality of our employees

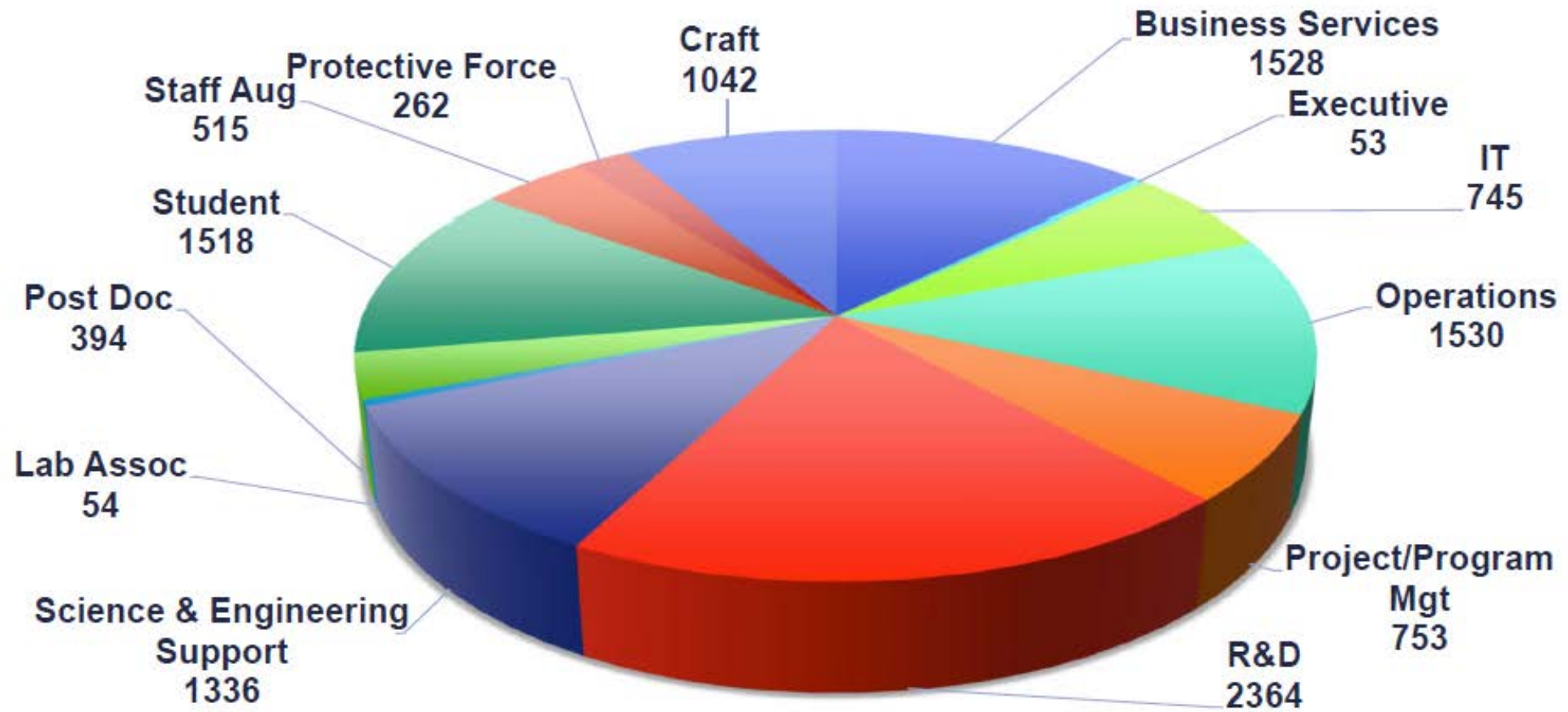

Today, the US has 11 nuclear weapon types, and Los Alamos has responsibility for 8 of the weapons

**LANL Weapons**

B61-3,-4,-7



**LLNL Weapons**



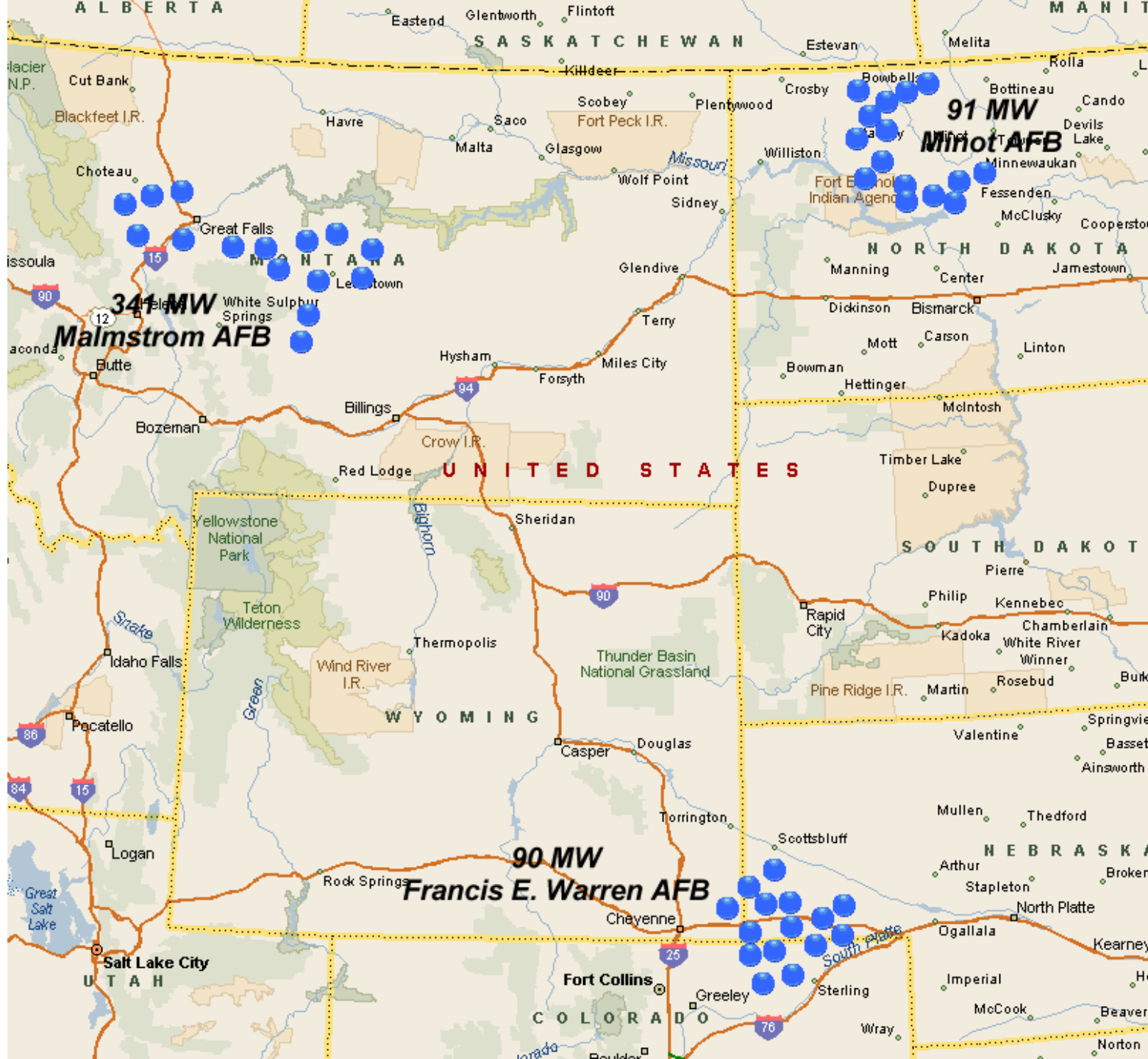

For the coming decade at least, a talk about new pits is also a talk about intercontinental ballistic missiles (ICBMs), both the existing Minuteman III's and the planned Ground-Based Strategic Deterrent (GBSD), a roughly \$80-140 billion program.

MM III's are deployed in 3 bases spread over 5 states. There are 150 silos at each base, divided into 3 wings of with 50 missiles apiece.

50 silos are in "warm standby," without missiles in them. Thus 400 missiles are deployed.





**W87, shown here in (retired) MX missile configuration, circular error probable (CEP) is classified but < 400 ft. Yield is 330/475 kilotons (kt). It is pits for this warhead or a variant which LANL is tasked to make.**

**The US possesses ~ 540 W87s, in addition to ~780 W78s in Mark 12A RVs (CEP ~720 ft) for the same 450 Minuteman III missiles.**

**At present, at least 200 MM IIIs could be returned to multiple independent RV (MIRV) status, with 3 W78 warheads each.**



**Mark 21/W87 on single RV MM III bus, the present deployment configuration.**

**This RV is too wide and heavy for MIRVing MM III.**

**MM III in operation.**

**Result.**

# MK 12A RE-ENTRY VEHICLE



**Skinnier,  
lighter, less  
accurate RV  
for the W78.**

# Pantex Zone 4 surplus pit and warhead magazines



~17,000 – 20,000 pits are here and in Zone 12

# TA-55 the Nation's center of plutonium science and processing

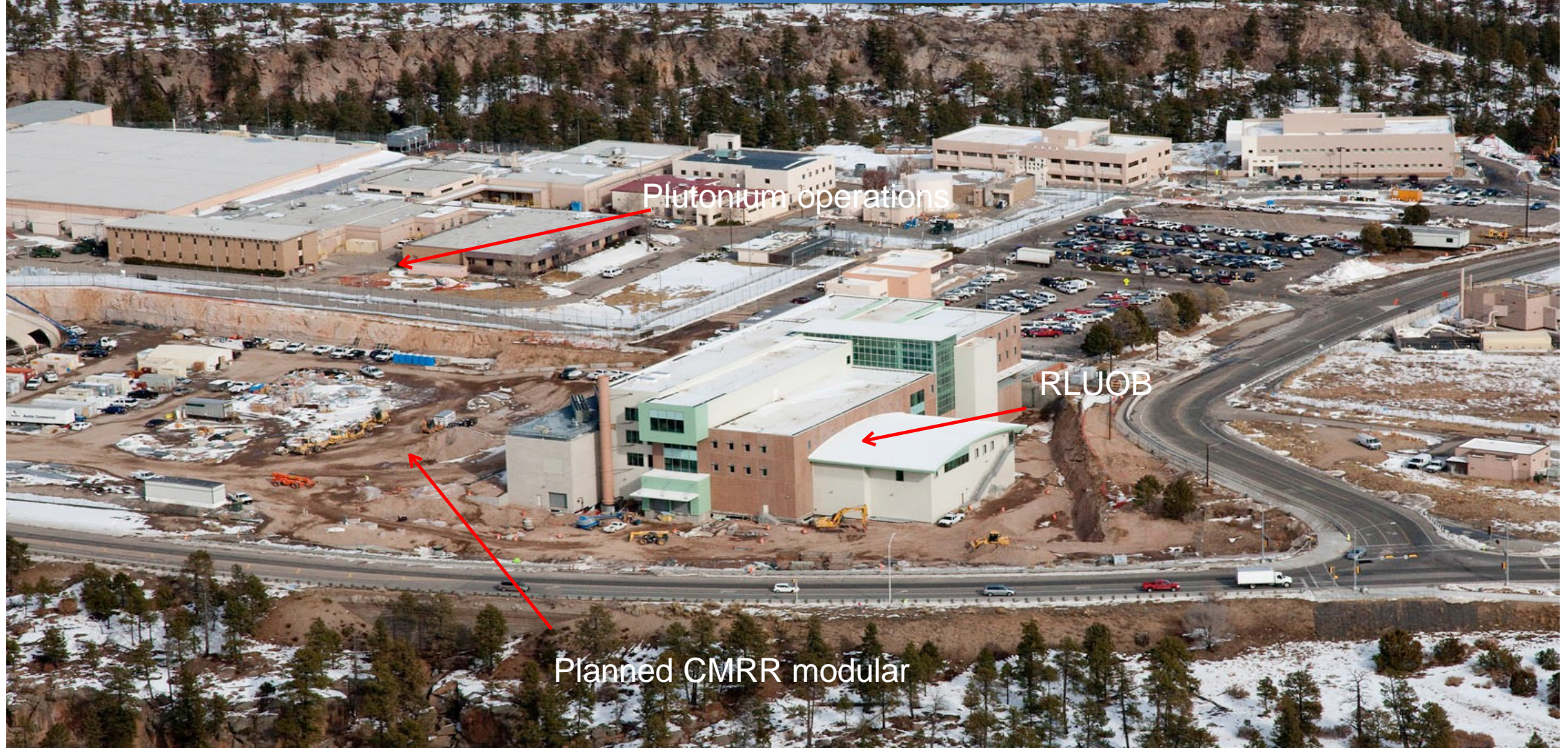

Plutonium operations

RLUOB

Planned CMRR modular

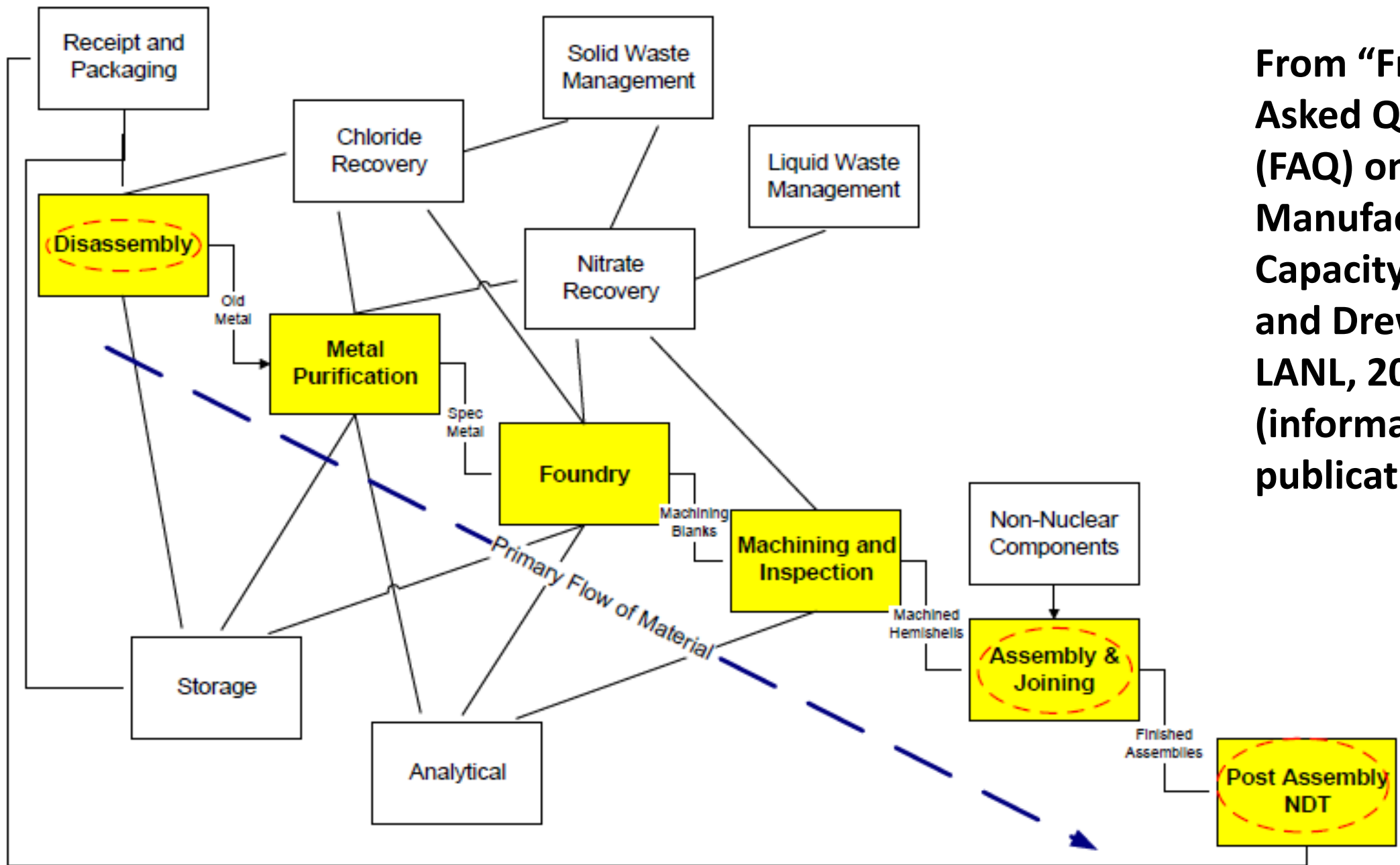

From “Frequently Asked Questions (FAQ) on Pit Manufacturing Capacity, Brett Kniss and Drew Kornreich, LANL, 2009 (informal publication)

Figure 1: The generic pit manufacturing flowsheet starting with raw materials (aged



**Coater**



**Plutonium Glove Box**

**Random scenes from the LANL pit production world**



Prior to this effort, high-mass operations in PF-4 had been shut down since June 2013.

One or two days after this triumphant picture was taken, another egregious criticality violation occurred and the program was shut down again.



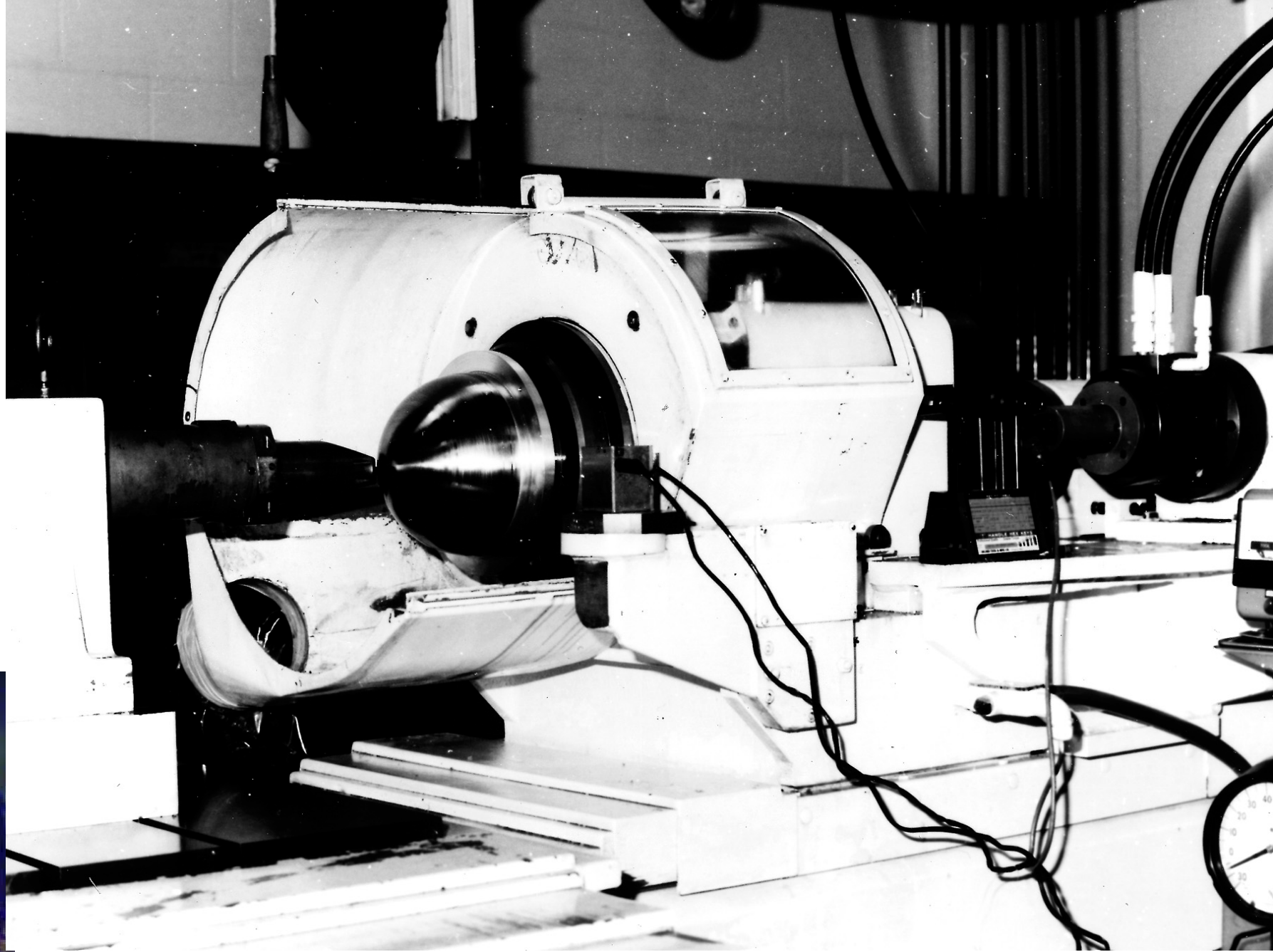

# Pit Manufacturing (casting)

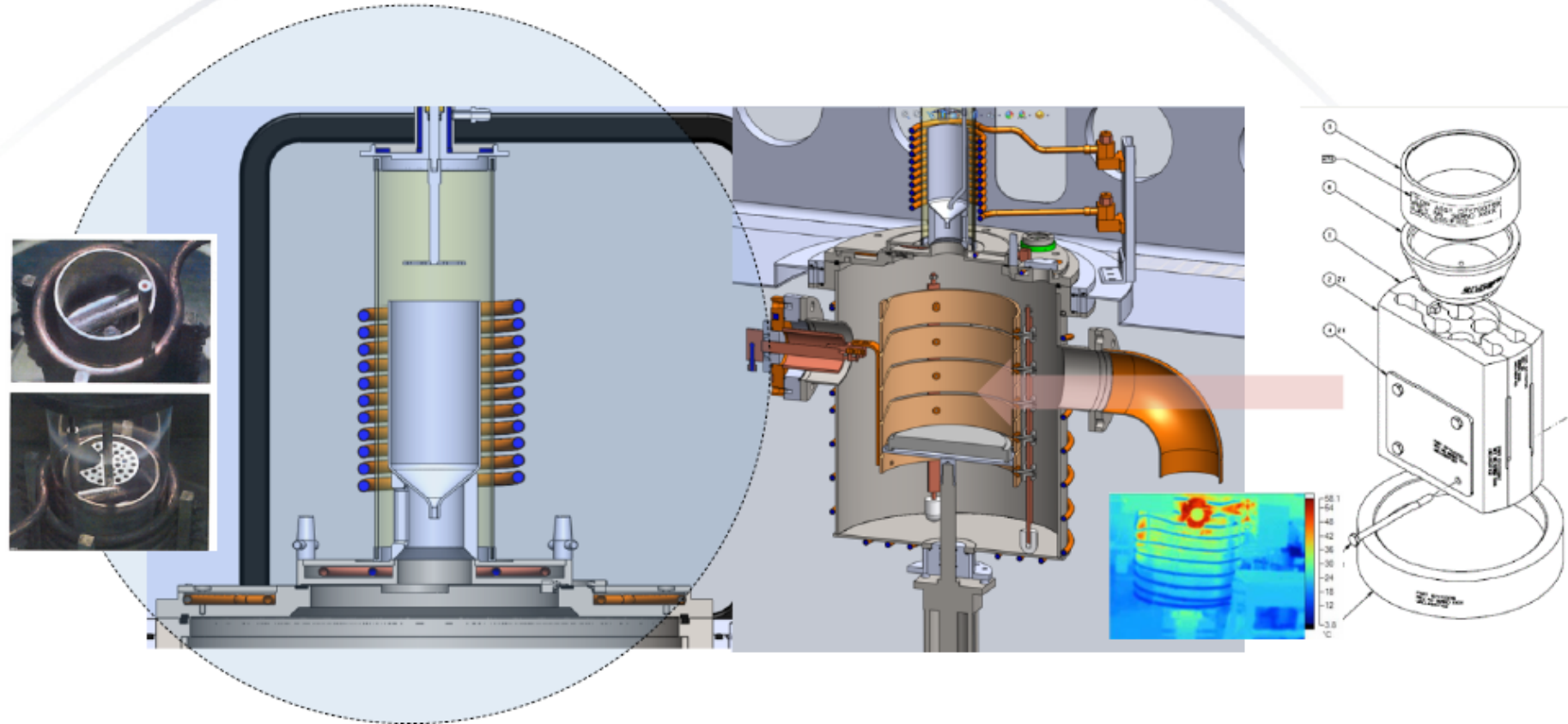

Upper Furnace

Lower Furnace

Casting Mold

UNCLASSIFIED



# Pit Manufacturing (machining)

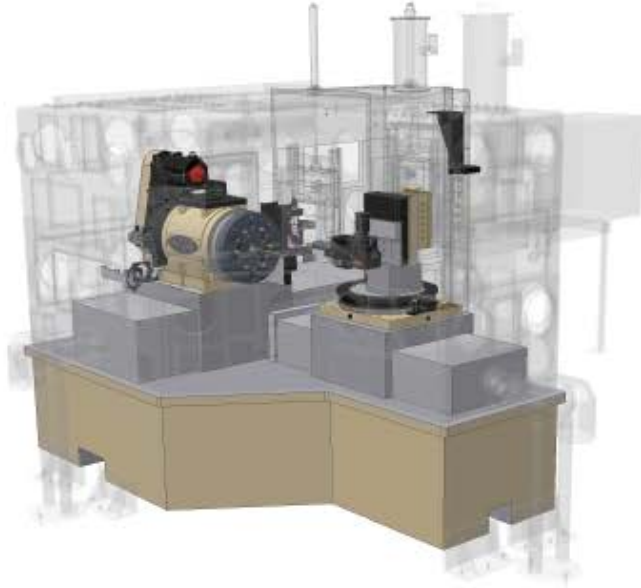





**Plutonium sustainment & prior comparable programs, annual current dollar (bars) & constant dollar (black line) spending. For FY2020 & after, requested.**

**Source: DOE budget requests.**

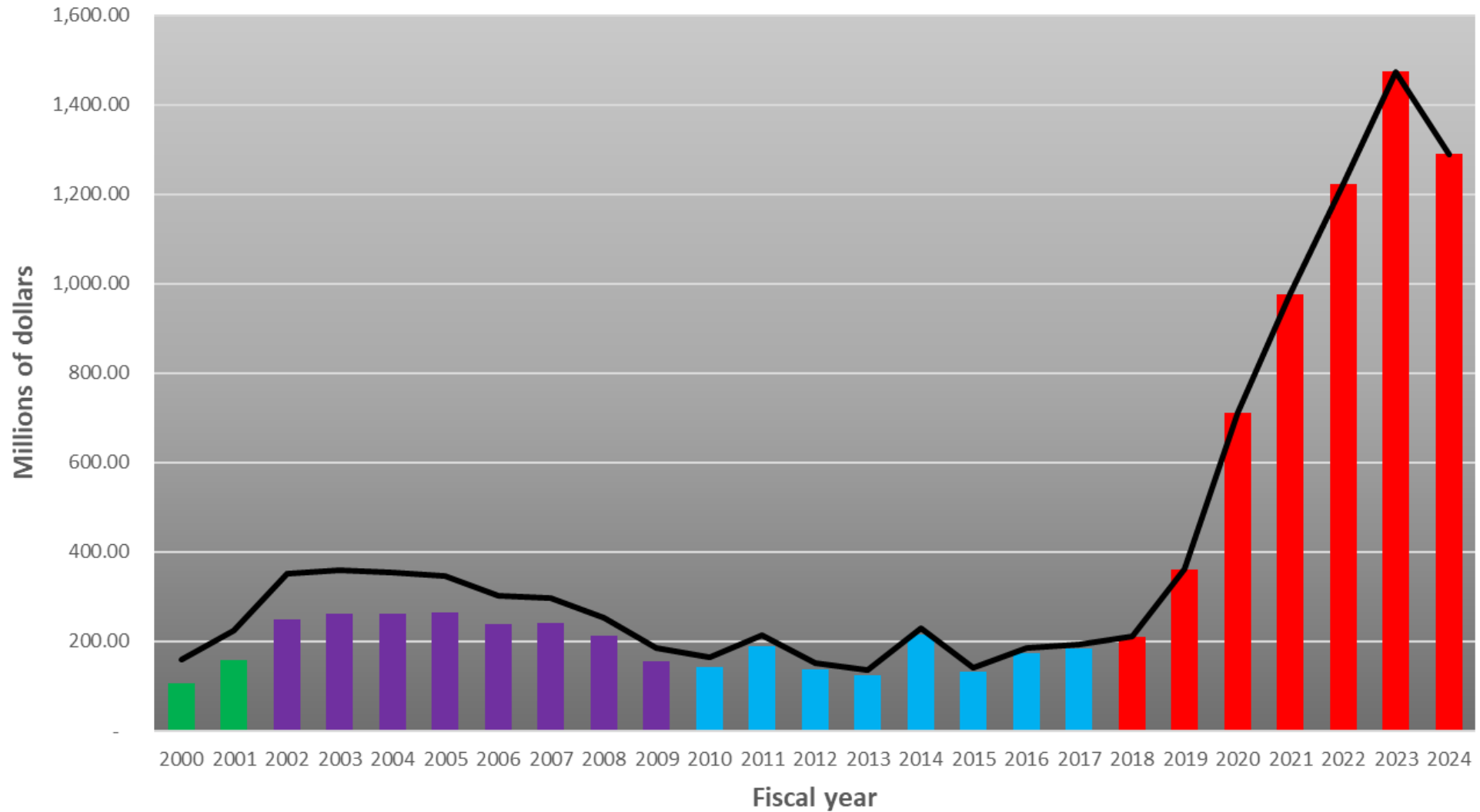

# Plutonium Sustainment Spending (Current, Planned) in \$M

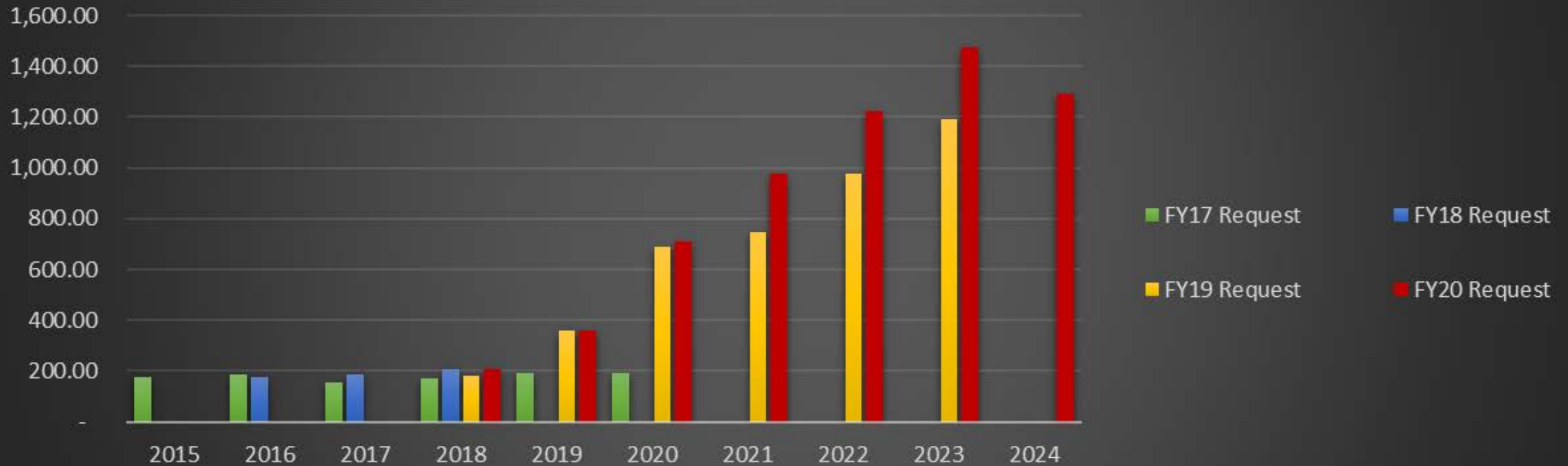



## *Special Nuclear Materials Research and Development Laboratory Replacement Project at Los Alamos National Laboratory*

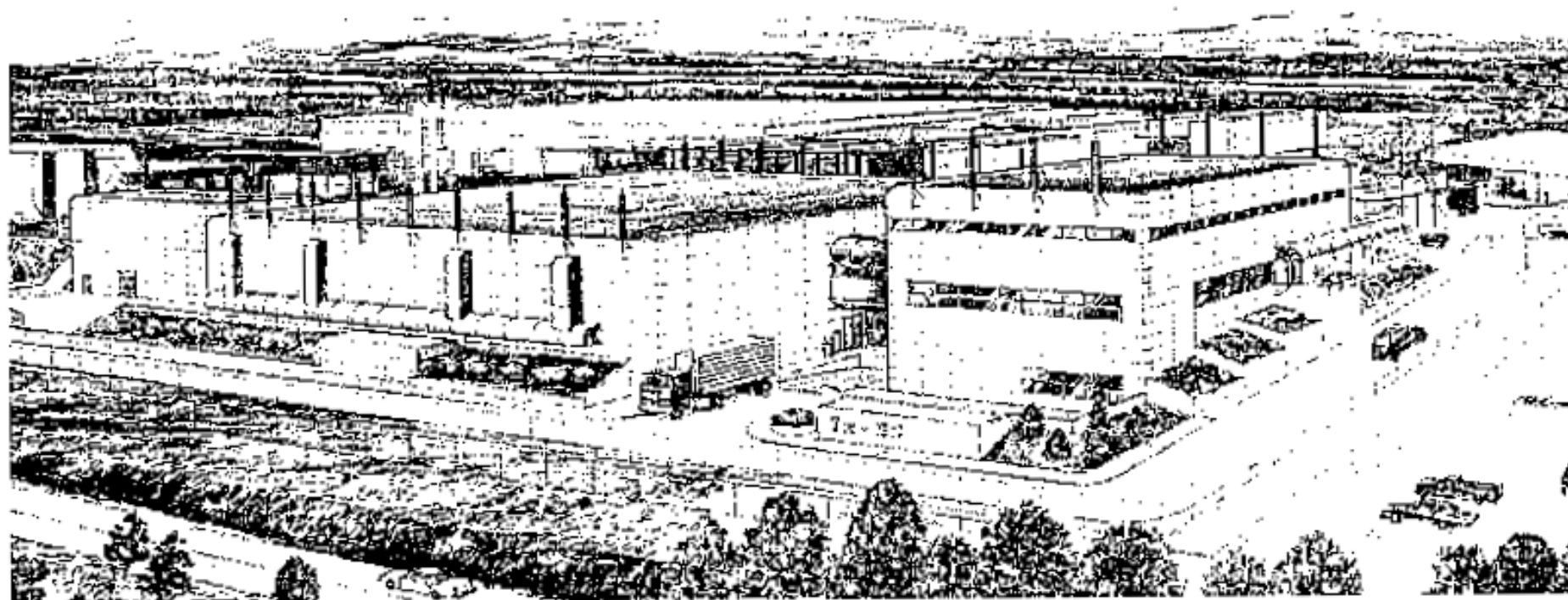

*Architectural rendering of the Special Nuclear Materials Research and Development Laboratory Replacement Project.*



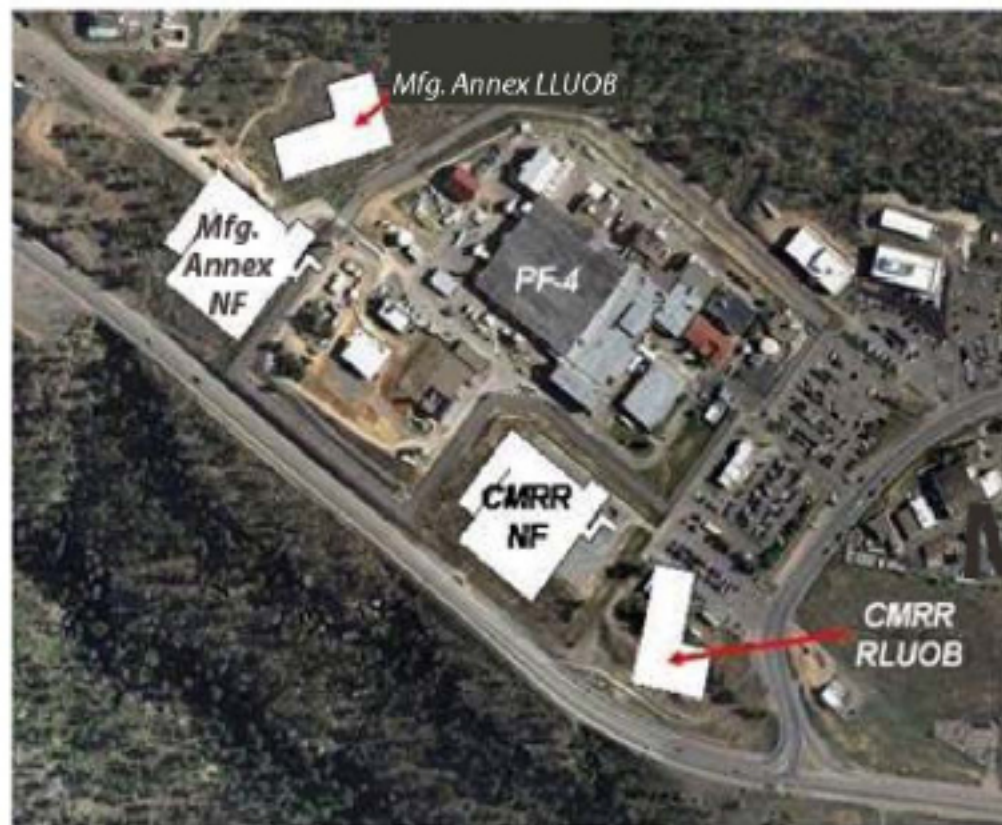

RLUOB = Radiological Laboratory/Utility/Office Building  
CMRR NF = Chemistry and Metallurgy Research Replacement Nuclear Facility  
LLUOB = Light Laboratory/Utility/Office Building

**Figure S.3.4.1-7—TA-55 Site Plan Showing the Proposed  
CMRR and Manufacturing Annex Facilities**

**S.3.4.1.2.2 Los Alamos Upgrade Alternative to Provide Up To 80 Pits per Year (“50/80**

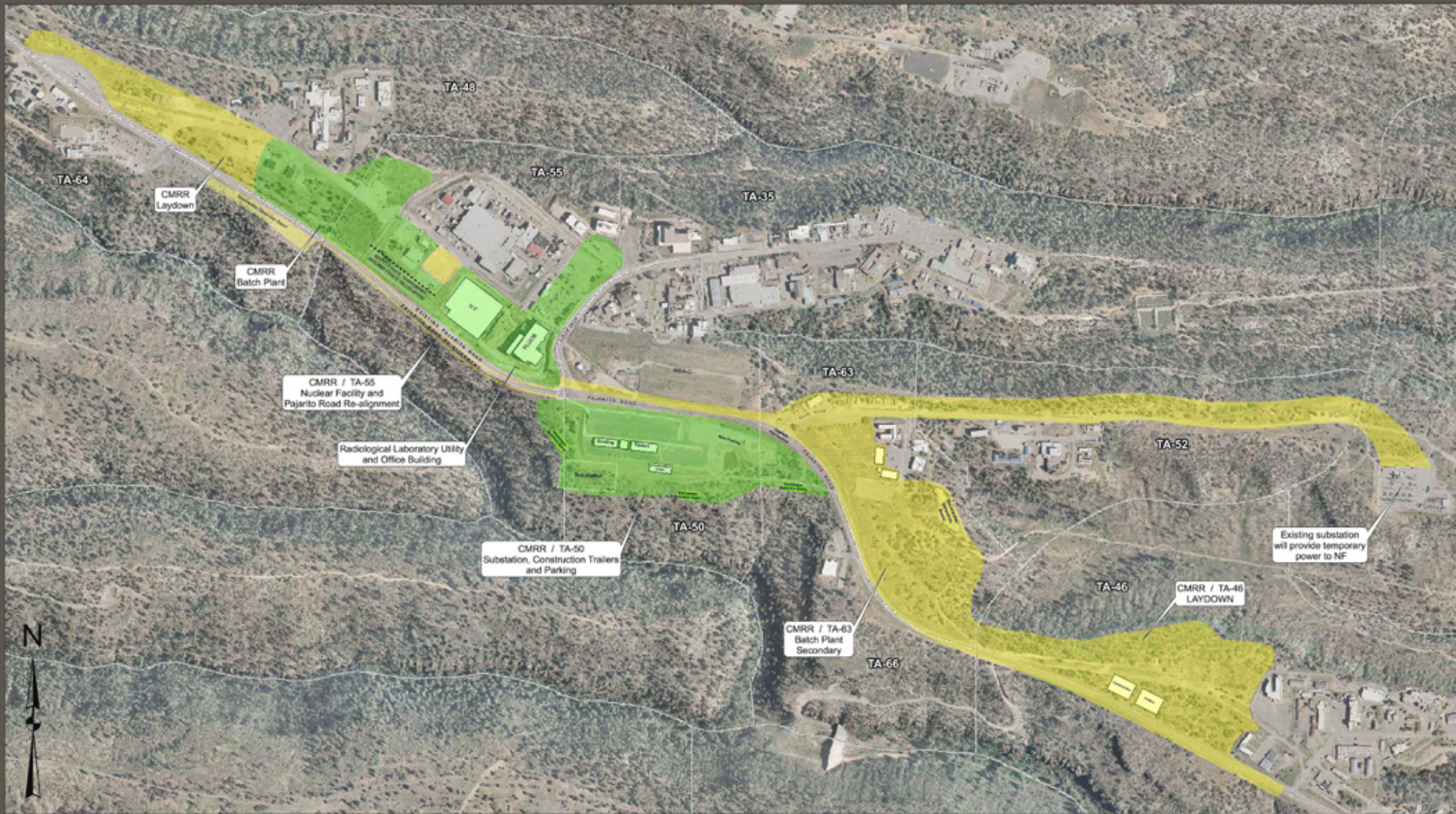

LA-UR 10-07047

PROPOSED PROJECT ACTIVITIES

**Legend**

- Proposed 2010/2011 SEIS Project Activities
- Previously Evaluated in 2003 EIS and 2005 SA
- Technical Area Boundary

PROJECTION: State Plane Coordinate System, New Mexico, Central Zone, U. S. Feet, GARTM NAD 83

SPACIAL DATA REFERENCES:  
 Aerial Photography: DRI/AF, September 2008  
 Roads, Features: ES 08  
 Metadata: AEL/LSAR, 03/04  
 Potential Release Site: ASEP-WEB, SP2009-0603

# CMRR Nuclear Facility Project Overview

October 2010

Aerial Photography - September 2008



UNCLASSIFIED

Site Planning & Project Initiation Group  
 Environmental Planning Office  
 LOS ALAMOS NATIONAL LABORATORY

**DISCLAIMER OF LIABILITY**  
 Neither the United States Government nor LANL, LLC nor any of their employees, makes any warranty, express or implied, including the accuracy of merchantability and fitness for a particular purpose, or assumes any legal liability or responsibility for the accuracy, completeness, or usefulness of any information, apparatus, product, or process disclosed, or represents that its use would not infringe privately owned rights.

**FOR PLANNING AND GENERAL PURPOSES ONLY.**  
 Using this map for anything other than its intended purpose may yield inaccurate or misleading results.

Design/Production: Environmental Planning Office  
 CDRP, Project, Operations, Plans, 10-100





# **Main issues NNSA faces w/ pit production**

- **Lack of solid mission need**
- **Bad conceptual design (esp. the “modules”)**
- **High and uncertain cost**
- **Recurrent poor facility management**
- **Long project duration (construction ends FY27)**
- **Recurrent poor project management**
- **Numerous fiscal “time bombs” in DOE and USA**
- **Competition for funds in government (DoD, others!)**
- **Instability of contract, work compatibility issues**

MFFF, Jan 2018





Is there a window of practical, safe pit production at LANL's PF-4? It is unlikely. (Los Alamos Study Group, 18 May 2019)																										
Year	19	20	21	22	23	24	25	26	27	28	29	30	31	32	33	34	35	36	37	38	39	40				
<b>Needed TA-55 and TA-50 infrastructure tests, analysis, and upgrades, not all-inclusive</b>																										
Column testing, seismic analysis; could be fatal to PF-4 operation as HC II Nuclear Facility; analysis may also limit MAR	(DNFSB WSR 12/28/18)	Necessity, feasibility, scope, and duration of possible PF-4 alterations are unknown at present					If needed, design and construction of a greenfield PF-4 replacement could begin in ~2022, with 30 ppy ops in ~2035. There is no room for a PF-4 replacement at TA-55. A separate 30 ppy production facility could not be built at TA-55 without massive disruption & risk. See other slides. PF-4 replacement, which is unlikely to be possible for a number of reasons, would be vastly expensive (>\$10 B).																			
PC-3 fire suppression system upgrade	(DNFSB WSR 1/4/19)																									
Internal firewall upgrade to 2 hours	(DNFSB WSR 1/4/19)																									
PC-3 active ventilation, fire alarm upgrade	(DNFSB WSR 1/4/19)																									
Fire water loop integrity	(DNFSB WSR 1/4/19)																									
CMRR subproject REI2	(DOE CBR)																									
CMRR subproject PEI1	(DOE CBR)																									
CMRR subproj. PEI2 (to Pu Pit Prod. Project, PPP)	(DOE CBR) Scope, cost, & duration of Pu Pit Proj. (PPP) unknown; purpose is to take LANL from 10 to 30 ppy so duration shown accordingly																									
CMRR subproj. RC3 (to PPP)																										
TA-55 Reinvest. Project III	Duration: >2024 (CBR) by ~2 yrs (estimate)																									
TRU liquid waste (TA-50)	Duration unclear but >2024 (CBR)																									
<b>War reserve (WR) pit production expected (pits per year, ppy)</b>																										
1	(funded by Pu Sustainment Ops)					X																				
10							X																			
20	(funded by Pu Pit Production Project, scope TBD)							X																		
30 (average)									X	X	X	X	X	X	X	X	X	X	X	X	X	X	X			
≥30 (NNSA: 41 average)	Infeasible (AoA p. 2)					We believe multi-shift production would lead to fairly prompt and repeated pauses and shut-downs due to single-point failures and overwhelmed chokepoints. Inadequate and inappropriate facilities, management, training, and institutional culture would be exposed. Existing PF-4 missions would be threatened, as would worker and public safety. Recovery could be difficult and might not be successful.																				
≥50 (NNSA: 84 average)	Infeasible (AoA p. 2)																									
≥80 (NNSA: 103 average)	Infeasible (AoA p. 2)																									
Cumulative WR pits (theoretical, 30 ppy average)						1	11	31	61	91	121	151	181	211	241	271	301	331	361	391	421	451	481			
<b>Model (heuristic only): probability of effective PF-4 end of life (EOL) by given year assuming normal distribution, 10 year standard deviation</b>																										
2039 est. EOL (NNSA, FY2014 CBR p. WA-211)	.02	.03	.04	.04	.05	.07	.08	.10	.12	.14	.16	.18	.21	.24	.27	.31	.34	.38	.42	.46	.50	.54				
2034 est. EOL (assumed earlier EOL with 30 ppy)	.07	.08	.04	.04	.05	.07	.08	.21	.24	.27	.31	.34	.38	.42	.46	.50	.54	.58	.62	.66	.69	.73				

## These pit production purposes fall into two clear groups

Essential plutonium missions undergird and complement the first group

- These basic missions have unambiguous value within overall program objectives, low to moderate cost, low to moderate management risk, and engender little controversy:
  - a. Pit surveillance
  - b. Pit aging studies
  - c. Targeted plutonium science
  - d. Retain production skills via pilot or demonstration production; transmit skills
  - e. Retain production technologies and develop them as needed
  - f. Inspect, reuse, and if needed repair (rebuild) pits
- These industrial missions have contested value, very high cost and risk, a track record of failure, and are controversial in themselves and in their implementation:
  - g. produce stockpile quantities of existing types of pits
  - h. produce stockpile quantities of new types of pits



# Why do some of us say that industrial pit production is virtually impossible at LANL?

- Isolation
- Dissected topography, e.g. at TA-55
- R&D culture
- Institutional arrogance
- Unconsolidated sediments
- Seismicity
- Aging facilities (PF-4); decrepit, unsafe facilities (Main Shops); unknown status (Sigma)
- RLUOB
- Negative social attributes of New Mexico
- Lack of qualified workforce, low educational attainment of population
- Local opposition

**It will be very difficult or impossible for LANL to establish industrial pit production at any scale for a multitude of reasons, all of which are independent of senior management actions. These factors are negatively synergistic in ways that have proven, and will prove, difficult to predict or prevent.**

- The industrial, cultural, and educational isolation of the site, which increases costs and creates program risks;
- LANL's dissected topography, which dramatically increases costs and places limits on construction;
- LANL's R&D culture, which is necessary to protect in order to attract young scientists and engineers, especially given LANL's isolated location;
- LANL's institutional arrogance, a product of isolation, enormously large relative income and generous benefits, low taxes and local high government subsidies and therefore excellent local schools, etc., and high formal educational attainment among LANL managers and technical staff in comparison to the surrounding region;
- The unconsolidated sediments that underlie TA-55 and other LANL sites, which together with the site's considerable seismicity (next bullet) increase costs and limit construction options;
- LANL's high seismicity, a problem that is amplified by known active on-site faults and hence possible ground rupture, the shallow location and high acceleration of earthquakes from them, seismic amplification from unconsolidated sediments, and the structural incompetence of all the rock at LANL;

## Why LANL can't do industrial pits, continued

- LANL's legacy nuclear facilities, which were built for R&D and of limited size; most of these will soon (relative to this mission) be at, or are already past, their reliable, safe, and useful lives; these include PF-4, the Main Shops, and Sigma, all of which are to have greater or lesser roles in pit production; tearing these facilities down will also be disruptive to a greater or lesser extent.
- The planned repurposing of a new radiological laboratory (RLUOB) as a HC3 nuclear facility; the success of this "bait-and-switch" operation is central to industrial pit production at LANL;
- The concatenation of difficulties and strain on support systems posed by multiple industrial plutonium missions at PF-4 (pit production, ARIES, Pu-238);
- The environment of corruption, complaisance, and low work standards that is pervasive in New Mexico, especially northern New Mexico, as a long-term result of poverty and lack of opportunity; very high incidence of drug use and associated crime of all kinds; this reinforces LANL arrogance and racism on the job as well as contributes synergistically to mistakes at work;
- The lack of a qualified regional workforce for LANL as a whole as well as for pit production and the low educational attainment of the surrounding population; a relative lack of post-secondary educational and vocational institutions; and
- The relative incompatibility of industrial plutonium operations and Santa Fe cultural pretensions; and
- Local opposition.